



BOT LIGHTING
FOR A BRIGHT FUTURE

APPARECCHI
APRILE 2021

BOT LIGHTING FOR A BRIGHT FUTURE

Supporter



Serie A
maschile
2019/20



Coppa Italia

Serie A
femminile
2020



Supercoppa



BOT LIGHTING CON KAI È PARTNER DELL'UMANA REYER, SQUADRA STORICA E ICONA DI VENEZIA. UNA PARTNERSHIP DALLA GRANDE VALENZA, EMBLEMA DELLA CONDIVISIONE DEI VALORI DELLO SPORT E DELLA PALLACANESTRO, GLI STESSI CHE BOT LIGHTING RIPONE NEL PROPRIO LAVORO A LIVELLO EUROPEO: LEALTÀ, PASSIONE, DETERMINAZIONE E IMPEGNO.



INDOOR RESIDENZIALE RESIDENTIAL INDOOR

WIRKKALA K2-142 LAMPADA A SOSPENSIONE LED / LED PENDANT LAMP	17
WIRKKALA K2-135 LAMPADA A SOSPENSIONE LED / LED PENDANT LAMP	18
WIRKKALA K2-140 LAMPADA A SOSPENSIONE LED / LED PENDANT LAMP	19
WIR LAMPPU K2-131 LAMPADA A SOSPENSIONE LED / LED PENDANT LAMP	20
WIR LAMPPU K2-80 KRS LAMPADA A SOSPENSIONE LED / LED PENDANT LAMP	21
WIR LAMPPU K2-105 LAMPADA A SOSPENSIONE LED / LED PENDANT LAMP	22
WIR-85 LAMPADINA A LED / LED LIGHT BULB	23
WIR-105 LAMPADINA A LED / LED LIGHT BULB	23
WIR-80 KRS LAMPADINA A LED / LED LIGHT BULB	23
CEILING BAR PER LAMPADA WIRKKALA / FOR WIRKKALA LAMP	24
CEILING CUP PER LAMPADA WIRKKALA / FOR WIRKKALA LAMP	25
LOFT35 LAMPADA A SOSPENSIONE / PENDANT LAMP	27
SANSA LAMPADA A SOSPENSIONE / PENDANT LAMP	29
CARA APPLIQUE CON FISSAGGIO CLIP / CLIP WALL LAMP	30
CARA APPLIQUE / WALL LAMP	31
CARA LAMPADA DA TAVOLO / TABLE LAMP	32
GILDA LAMPADA DA TAVOLO CON DIMMER / TABLE LAMP WITH DIMMER	34
ILLUSION LAMPADA DA TAVOLO LED / LED TABLE LAMP	36
LIV DESK LAMPADA DA TAVOLO / TABLE LAMP	39
NITA DESK LAMPADA DA TAVOLO / TABLE LAMP	41
GIADA PLAFONIERA AD ALTA RESISTENZA IMPERMEABILE / HIGH RESISTANCE & WATERPROOF CEILING LIGHT	42
GIADA ACCESSORI / ACCESSORIES	43
COCO PLAFONIERA / CEILING LIGHT	44
RIO & RIO RADAR PLAFONIERA / CEILING LIGHT	45-46
SONO III PIR PLAFONIERA PIR / PIR CEILING LIGHT	47

OUTDOOR RESIDENZIALE RESIDENTIAL OUTDOOR

GIRONA APPLIQUE / WALL LIGHT	50
ALICANTE APPLIQUE / WALL LIGHT	51
NÄSBY II APPLIQUE / WALL LIGHT	53
MARBELLA SQUARED APPLIQUE / WALL LIGHT	54
MARBELLA ROUND APPLIQUE / WALL LIGHT	55
TOLEDO APPLIQUE SINGOLA EMISSIONE / MONO EMISSION WALL LAMP	56
TOLEDO APPLIQUE DOPPIA EMISSIONE / DOUBLE EMISSION WALL LAMP	57
SUND APPLIQUE SINGOLA EMISSIONE / MONO EMISSION WALL LAMP	58
SUND APPLIQUE DOPPIA EMISSIONE / DOUBLE EMISSION WALL LAMP	59
CORDOVA APPLIQUE SINGOLA EMISSIONE / MONO EMISSION WALL LAMP	60
CORDOVA APPLIQUE DOPPIA EMISSIONE / DOUBLE EMISSION WALL LAMP	61
ALPPILA 1S APPLIQUE SINGOLA EMISSIONE / MONO EMISSION WALL LAMP	62
ALPPILA 2S APPLIQUE DOPPIA EMISSIONE / DOUBLE EMISSION WALL LAMP	63
ALPPILA XL APPLIQUE DOPPIA EMISSIONE / DOUBLE EMISSION WALL LAMP	64
GRANADA APPLIQUE DOPPIA EMISSIONE / DOUBLE EMISSION WALL LAMP	65
ARVIKA APPLIQUE / WALL LAMP	66
AURA APPLIQUE / WALL LAMP	67
ALTA APPLIQUE / WALL LAMP	68
MAIORCA APPLIQUE / WALL LAMP	69
SEGOVIA 1 APPLIQUE / WALL LAMP	70
SEGOVIA 2 APPLIQUE / WALL LAMP	71
SEGOVIA 3 APPLIQUE / WALL LAMP	72
SEGOVIA ACCESSORI / ACCESSORIES	73
LEON LANTERNA / LANTERN LAMP	74
SIVIGLIA APPLIQUE / WALL LAMP	75
SIVIGLIA PALETTO DA GIARDINO / OUTDOOR BOLLARD	76
KALLIO PALETTO DA GIARDINO / OUTDOOR BOLLARD	77

PUUTARHAKOHDEVALO PICCHETTO DA GIARDINO / OUTDOOR STAKE LIGHT	78
KURU PICCHETTO DA GIARDINO / OUTDOOR STAKE LIGHT	79
BILBAO SQUARED SEGNAPASSO / STEP LIGHT	80
BILBAO SQUARED SEGNAPASSO / STEP LIGHT	81
BILBAO ROUND SEGNAPASSO / STEP LIGHT	82
BILBAO ROUND SEGNAPASSO / STEP LIGHT	83
HOLM SEGNAPASSO / STEP LIGHT	85
GARDA LAMPADINE DA GIARDINO / OUTDOOR GARDEN LAMPS	87

SOLARI SOLARS

FLAME2N TORCIA A LED EFFETTO FIAMMA - CREPUSCOLARE LED TORCH WITH FLAME EFFECT - DUSK SENSOR	90
YUMA2N PROIETTORE SOLARE SOLAR FLOODLIGHT	92
YUMA5N PROIETTORE SOLARE SOLAR FLOODLIGHT	93
YUMA10N PROIETTORE SOLARE SOLAR FLOODLIGHT	94
YUMA10NS PROIETTORE SOLARE CON PANNELLO ESTERNO FLOODLIGHT WITH EXTERNAL SOLAR PANEL	97
YUMA20NP PALETTO SOLARE DA GIARDINO SOLAR BOLLARD GARDEN LIGHT	98
YUMA15N PROIETTORE SOLARE SOLAR FLOODLIGHT	101
YUMA40N PROIETTORE SOLARE STRADALE A LED SOLAR LED STREET FLOODLIGHT	102

INDOOR TECNICO TECHNICAL INDOOR

PANNELLO LED 600X600 A ELEVATO COMFORT VISIVO 600X600 LED PANEL WITH HIGH VISUAL COMFORT	106
PANNELLO LED 600X600 ALTA EFFICIENZA 100LM/W HIGH EFFICIENCY 600X600 LED PANEL 100LM/W	107
PANNELLO LED 300X1200 ALTA EFFICIENZA 100LM/W HIGH EFFICIENCY 300X1200 LED PANEL 100LM/W	108
PANNELLO LED 300X1200 A ELEVATO COMFORT VISIVO 300X1200 LED PANEL WITH HIGH VISUAL COMFORT	109
PANNELLO LED 600X600 ALTISSIMA EFFICIENZA 110LM/W UGR<19 / LED PANEL 600X600 VERY HIGH EFFICIENCY 110LM / W UGR <19	110

PANNELLO LED RETROILLUMINATO 600X600 ALTA EFFICIENZA 100LM/W HIGH EFFICIENCY 600X600 BACKLIT LED PANEL 100LM/W	111
PANNELLO LED RETROILLUMINATO 600X600 ALTA EFFICIENZA 90LM/W - UGR < 19 HIGH EFFICIENCY 600X600 BACKLIT LED PANEL 90LM/W- UGR <19	112
LED DRIVER CORRENTE COSTANTE PER LED PANEL CONSTANT CURRENT LED DRIVER FOR LED PANEL	114
KIT MONTAGGIO PANNELLI / PANELS MOUNTING KIT	114
DRIVER DALI / PUSH / 0-10 MULTIFUNZIONE MULTIFUNCTIONAL DALI / PUSH / 0-10V DALI DRIVER	116
KIT EMERGENZA MULTIFUNZIONE / MULTIFUNCTIONAL EMERGENCY KIT	118
DOWNLIGHT CIO DIMMERABILE / DIMMABLE	121
DOWNLIGHT OSLO ROUND CON CORNICE INTERCAMBIABILE / WITH INTERCHANGEABLE FRAME	122
DOWNLIGHT BIG OSLO ROUND CON CORNICE INTERCAMBIABILE / WITH INTERCHANGEABLE FRAME	123
DOWNLIGHT OSLO SQUARED CON CORNICE INTERCAMBIABILE / WITH INTERCHANGEABLE FRAME	124
DOWNLIGHT PRO Ø170 DIMMERABILE / DIMMABLE	126
DOWNLIGHT PRO Ø220 DIMMERABILE / DIMMABLE	127
DOWNLIGHT SLIM PRO	128
MODIGLIANI MODULO LED CRI>90 DIMMERABILE DIMMABLE LED MODULE CRI> 90	129
ANELLI DI FISSAGGIO ORIENTABILI / ADJUSTABLE FIXING RINGS	131
CENTER PROIETTORE PER BINARIO / TRACKLIGHT	132-133
CENTER FOOD PROIETTORE DA BINARIO PER CARNE / TRACKLIGHT FOR MEAT	135
CENTER FOOD PROIETTORE DA BINARIO PER PANE E VEGETALI TRACKLIGHT FOR BREAD OR VEGETABLES	136
VIENNA CRI>97 PROIETTORE DA BINARIO / TRACKLIGHT	138
BINARI E ACCESSORI / TRACKLIGHT AND ACCESSORIES	140-143
SISTEMA MODULARE DI BARRE LED T5 T5 LED BARS - MODULAR SYSTEM	144
SHOT S-FLAT LED	145
STRIP LED 12V / 12V LED STRIP	147
STRIP LED 24V / 24V LED STRIP	148
DRIVER PER STRIP LED STRIP LED DRIVER	149
MOD-A MODULO LED CIRCOLARE MAGNETICO DI 2° GENERAZIONE SECOND GENERATION MAGNETIC CIRCULAR LED MODULE	150
MOD-B MODULO LED CIRCOLARE MAGNETICO DI 2° GENERAZIONE SECOND GENERATION MAGNETIC CIRCULAR LED MODULE	151

OUTDOOR TECNICO TECHNICAL OUTDOOR

ORLANDO 10 PROIETTORE A LED / LED FLOODLIGHT	154
ORLANDO 20 - 20PIR PROIETTORE A LED / LED FLOODLIGHT	155
ORLANDO 30 - 30PIR PROIETTORE A LED / LED FLOODLIGHT	156
ORLANDO 50 PROIETTORE A LED LED FLOODLIGHT	157
ORLANDO 90 PROIETTORE A LED / LED FLOODLIGHT	158
DENVER PROIETTORE A LED / LED FLOODLIGHT	160
DENVER PROIETTORE A LED SLIM SENSORE MICROONDE DI MOVIMENTO SLIM LED FLOODLIGHT WITH MICROWAVE MOTION SENSOR	161
KYOTO 100 PROIETTORE A LED PROFESSIONALE PROFESSIONAL LED FLOODLIGHT	162
KYOTO 150 PROIETTORE A LED PROFESSIONALE PROFESSIONAL LED FLOODLIGHT	163
KYOTO 200 PROIETTORE A LED PROFESSIONALE PROFESSIONAL LED FLOODLIGHT	164
KYOTO 300 PROIETTORE A LED PROFESSIONALE PROFESSIONAL LED FLOODLIGHT	165
AKRON PROIETTORE A LED 12/24V 12/24V LED FLOODLIGHT	166
STAND PER PROIETTORE - CONNETTORI STAGNI IP68 FLOODLIGHT STAND - IP68 WATERPROOF CONNECTORS	167
CACTUS PROIETTORE STRADALE A LED LED STREETLIGHT	168
PLAFONIERA STAGNA A LED SLIM SLIM LED TRI-PROOF	170
PLAFONIERA STAGNA A LED SLIM - PASSANTE SLIM LED TRI-PROOF - PASS THROUGH	171
PLAFONIERA STAGNA A LED SLIM - EMERGENZA SLIM LED TRI-PROOF - EMERGENCY	172
PLAFONIERA STAGNA A LED SLIM - RADAR SLIM LED TRI-PROOF - RADAR	173
PLAFONIERA STAGNA A LED - EMERGENZA LED TRI-PROOF - EMERGENCY	175
PLAFONIERA STAGNA LED LED TRI-PROOF	176
SCHERMO DI RICAMBIO PER PLAFONIERA STAGNA LED CLIP DI RICAMBIO PLAFONIERA STAGNA LED SPARE DIFFUSER FOR LED TRI-PROOF - SPARE CLIPS FOR LED TRI-PROOF	177
LED HIGH BAY	178
STAFFA - DIFFUSORE 60°/90° PER HIGH BAY LD1HB BRACKET - DIFFUSER 60°/90° FOR HIGH BAY LD1HB	179

HIGH BAY - LED DOB / STAFFA / BRACKET	180
HIGH BAY LED ALTA POTENZA + STAFFA HIGH POWER + BRACKET	181

WORKLIGHT

LAMPADA DA TAVOLO CONLENTE DI INGRANDIMENTO 3D (1.75X) E CLIP DI FISSAGGIO / TABLE LAMP WITH 3D MAGNIFYING LENS (1.75X) AND FIXING CLIP	184
LAMPADA DA TAVOLO CONLENTE DI INGRANDIMENTO 3D (1.75X) E CLIP DI FISSAGGIO A VITE / TABLE LAMP WITH 3D MAGNIFYING LENS (1.75X) AND SCREW FIXING CLIP	185
WORK25 PROIETTORE PORTATILE A LED PROFESSIONALE PROFESSIONAL PORTABLE LED FLOODLIGHT	186
WORK45 PROIETTORE PORTATILE A LED PROFESSIONALE PROFESSIONAL PORTABLE LED FLOODLIGHT	187
FIORA LAMPADA A SOSPENSIONE A LED PER CRESCITA PIANTE LED SUSPENSION LAMP FOR PLANT GROWTH	189
HERBY LAMPADA DA TAVOLO A LED PER CRESCITA PIANTE LED TABLE LAMP FOR PLANT GROWTH	191

GLOSSARIO GLOSSARY

192-194

GARANZIA WARRANTY

196

198

CONDIZIONI DI VENDITA SALES CONDITIONS

197

199

BOT LIGHTING
FOR A BRIGHT FUTURE

INDOOR RESIDENZIALE RESIDENTIAL INDOOR



WIRKKALA K2-142
LAMPADA A SOSPENSIONE LED
LED PENDANT LAMP
P. 17



WIRKKALA K2-135
LAMPADA A SOSPENSIONE LED
LED PENDANT LAMP
P. 18



WIRKKALA K2-140
LAMPADA A SOSPENSIONE LED
LED PENDANT LAMP
P. 19



WIR LAMPPU K2-131
LAMPADA A SOSPENSIONE LED
LED PENDANT LAMP
P. 20



WIR LAMPPU K2-80 KRS
LAMPADA A SOSPENSIONE LED
LED PENDANT LAMP
P. 21



WIR LAMPPU K2-105
LAMPADA A SOSPENSIONE LED
LED PENDANT LAMP
P. 22



WIR-85
LAMPADINA A LED
LED LIGHT BULB
P. 23



WIR-105
LAMPADINA A LED
LED LIGHT BULB
P. 23



WIR-80 KRS
LAMPADINA A LED
LED LIGHT BULB
P. 23



CEILING BAR
PER LAMPADA WIRKKALA
FOR WIRKKALA LAMP
P. 24



CEILING CUP
PER LAMPADA WIRKKALA
FOR WIRKKALA LAMP
P. 25



LOFT35
LAMPADA A SOSPENSIONE
PENDANT LAMP
P. 27



SANSA
LAMPADA A SOSPENSIONE
PENDANT LAMP
P. 29



CARA CLIP
APPLIQUE CON FISSAGGIO CLIP
CLIP WALL LAMP
P. 30



CARA CLIP
APPLIQUE
WALL LAMP
P. 31

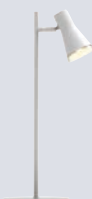

CARA
LAMPADA DA TAVOLO
TABLE LAMP
P. 32



GILDA
LAMPADA DA TAVOLO CON DIMMER
TABLE LAMP WITH DIMMER
P. 34



ILLUSION
LAMPADA DA TAVOLO LED
LED TABLE LAMP
P. 36



LIV DESK
LAMPADA DA TAVOLO
TABLE LAMP
P. 39



NITA DESK
LAMPADA DA TAVOLO
TABLE LAMP
P. 41



GIADA
PLAFONIERA AD ALTA RESISTENZA IMPERMEABILE
HIGH RESISTANCE & WATERPROOF CEILING LIGHT
P. 42

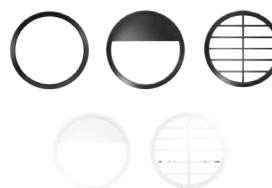

GIADA
ACCESSORI
ACCESSORIES
P. 43



COCO
PLAFONIERA
CEILING LIGHT
P. 44



RIO & RIO RADAR
PLAFONIERA
CEILING LIGHT
P. 45-46

IP44
RADAR



SONO III PIR
PLAFONIERA PIR
PIR CEILING LIGHT
P. 47

IP54
PIR

OUTDOOR RESIDENZIALE
RESIDENTIAL OUTDOOR



GIRONA
APPLIQUE
WALL LIGHT
P. 50

IP65



ALICANTE
APPLIQUE
WALL LIGHT
P. 51

IP54



NÄSBY II
APPLIQUE
WALL LIGHT
P. 53

IP54



MARBELLA SQUARED
APPLIQUE
WALL LIGHT
P. 54

IP54



MARBELLA ROUND
APPLIQUE
WALL LIGHT
P. 55

IP54



TOLEDO
APPLIQUE SINGOLA EMISSIONE
MONO EMISSION WALL LAMP
P. 56

IP54



TOLEDO
APPLIQUE DOPPIA EMISSIONE
DOUBLE EMISSION WALL LAMP
P. 57

IP54



SUND
APPLIQUE SINGOLA EMISSIONE
MONO EMISSION WALL LAMP
P. 58

IP44



SUND
APPLIQUE DOPPIA EMISSIONE
DOUBLE EMISSION WALL LAMP
P. 59

IP44



CORDOVA
APPLIQUE SINGOLA EMISSIONE
MONO EMISSION WALL LAMP
P. 60

IP54



CORDOVA
APPLIQUE DOPPIA EMISSIONE
DOUBLE EMISSION WALL LAMP
P. 61

IP54



ALPPILA 1S
APPLIQUE SINGOLA EMISSIONE
MONO EMISSION WALL LAMP
P. 62

IP44



ALPPILA 2S
APPLIQUE DOPPIA EMISSIONE
DOUBLE EMISSION WALL LAMP
P. 63

IP44



ALPPILA XL
APPLIQUE DOPPIA EMISSIONE
DOUBLE EMISSION WALL LAMP
P. 64

IP44



GRANADA
APPLIQUE DOPPIA EMISSIONE
DOUBLE EMISSION WALL LAMP
P. 65

IP54



ARVIKA
APPLIQUE
WALL LAMP
P. 66

IP44



AURA
APPLIQUE
WALL LAMP
P. 67

IP54



ALTA
APPLIQUE
WALL LAMP
P. 68

IP44



MAIORCA
APPLIQUE
WALL LAMP
P. 69

IP54



SEGOVIA 1
APPLIQUE
WALL LAMP
P. 70

IP54



SEGOVIA 2
APPLIQUE
WALL LAMP
P. 71

IP54



IP54

SEGOVIA 3
APPLIQUE
WALL LAMP
P. 72



SEGOVIA
ACCESSORI
ACCESSORIES
P. 73



IP44

LEON
LANTERNA
LANTERN LAMP
P. 74

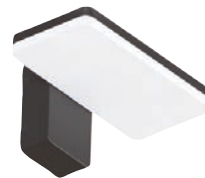

IP65

SIVIGLIA
APPLIQUE
WALL LAMP
P. 75

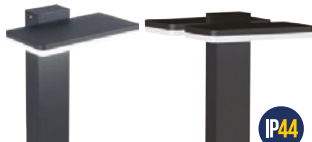

IP44

SIVIGLIA
PALETTO DA GIARDINO
OUTDOOR BOLLARD
P. 76



IP44

KALLJO
PALETTO DA GIARDINO
OUTDOOR BOLLARD
P. 77



IP44

PUUTARHAKOHDEVALO
PICCHETTO DA GIARDINO
OUTDOOR STAKE LIGHT
P. 78



IP54

KURU
PICCHETTO DA GIARDINO
OUTDOOR STAKE LIGHT
P. 79



IP54

BILBAO SQUARED
SEGNAPASSO
STEP LIGHT
P. 80



IP54

BILBAO SQUARED
SEGNAPASSO
STEP LIGHT
P. 81

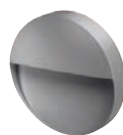

IP54

BILBAO ROUND
SEGNAPASSO
STEP LIGHT
P. 82



IP54

BILBAO ROUND
SEGNAPASSO
STEP LIGHT
P. 83



IP65

HOLM
SEGNAPASSO
STEP LIGHT
P. 85



IP44

GARDA
LAMPADIE DA GIARDINO
OUTDOOR GARDEN LAMPS
P. 87

SOLARI SOLARS



IP65

FLAME2N
TORCIA A LED EFFETTO FIAMMA - CREPUSCOLARE
LED TORCH WITH FLAME EFFECT - DUSK SENSOR
P. 90



IP65

YUMA2N
PROIETTORE SOLARE
SOLAR FLOODLIGHT
P. 92



IP65

YUMA5N
PROIETTORE SOLARE
SOLAR FLOODLIGHT
P. 93



IP65

YUMA10N
PROIETTORE SOLARE
SOLAR FLOODLIGHT
P. 94



IP65

PIR

YUMA10NS
PROIETTORE SOLARE CON PANNELLO ESTERNO
FLOODLIGHT WITH EXTERNAL SOLAR PANEL
P. 97



IP65

PIR

YUMA20NP
PALETTO SOLARE DA GIARDINO
SOLAR BOLLARD GARDEN LIGHT
P. 98



IP65

YUMA15N
PROIETTORE SOLARE
SOLAR FLOODLIGHT
P. 101



IP65

PIR

YUMA40N
PROIETTORE SOLARE STRADALE A LED
SOLAR LED STREET FLOODLIGHT
P. 102

INDOOR TECNICO
TECHNICAL INDOOR



CRI>90
UGR <19

PANNELLO LED 600X600 A ELEVATO COMFORT VISIVO
600X600 LED PANEL WITH HIGH VISUAL COMFORT
P. 106



PANNELLO LED 600X600 ALTA EFFICIENZA 100LM/W
HIGH EFFICIENCY 600X600 LED PANEL 100LM/W
P. 107



PANNELLO LED 300X1200 ALTA EFFICIENZA 100LM/W
HIGH EFFICIENCY 300X1200 LED PANEL 100LM/W
P. 108

NEW

CRI>90
UGR <19

PANNELLO LED 300X1200 A ELEVATO COMFORT VISIVO
300X1200 LED PANEL WITH HIGH VISUAL COMFORT
P. 109

UGR <19

PANNELLO LED 600X600 ALTISSIMA EFFICIENZA
110LM/W UGR<19
LED PANEL 600X600 VERY HIGH EFFICIENCY
110LM/W UGR <19
P. 110

PANNELLO LED RETROILLUMINATO 600X600 ALTA EFFICIENZA 100LM/W
HIGH EFFICIENCY 600X600 BACKLIT LED PANEL
100LM/W
P. 111

NEW

UGR <19

PANNELLO LED RETROILLUMINATO 600X600 ALTA EFFICIENZA 90LM/W - UGR <19
HIGH EFFICIENCY 600X600 BACKLIT LED PANEL
90LM/W - UGR <19
P. 112

LED DRIVER CORRENTE COSTANTE PER LED PANEL
CONSTANT CURRENT LED DRIVER FOR LED PANEL
P. 114

KIT MONTAGGIO PANNELLI
PANELS MOUNTING KIT
P. 114

DRIVER DALI / PUSH / 0-10V
MULTIFUNZIONE
MULTIFUNCTIONAL
P. 116

KIT EMERGENZA MULTIFUNZIONE
MULTIFUNCTIONAL EMERGENCY KIT
P. 118

DOWNLIGHT OSLO ROUND
DIMMERABILE
DIMMABLE
P. 121

DOWNLIGHT OSLO ROUND
CON CORNICE INTERCAMBIABILE
WITH INTERCHANGEABLE FRAME
P. 122

NEW

DOWNLIGHT BIG OSLO ROUND
CON CORNICE INTERCAMBIABILE
WITH INTERCHANGEABLE FRAME
P. 123

DOWNLIGHT OSLO SQUARED
CON CORNICE INTERCAMBIABILE
WITH INTERCHANGEABLE FRAME
P. 124

DOWNLIGHT PRO Ø170
DIMMERABILE
DIMMABLE
P. 126

IP44

DOWNLIGHT PRO Ø220
DIMMERABILE
DIMMABLE
P. 127

IP44

DOWNLIGHT SLIM PRO
P. 128

IP54

MODIGLIANI
MODULO LED CRI-90 DIMMERABILE
DIMMABLE LED MODULE CRI>90
P. 129

CRI>90

ANELLI DI FISSAGGIO ORIENTABILI
ADJUSTABLE FIXING RINGS
P. 131

IP65

CENTER
PROIETTORE PER BINARIO
TRACKLIGHT
P. 132-133

CRI-90

CENTER FOOD
PROIETTORE DA BINARIO PER CARNE
TRACKLIGHT FOR MEAT
P. 135

CENTER FOOD
PROIETTORE DA BINARIO PER PANE E VEGETALI
TRACKLIGHT FOR BREAD OR VEGETABLES
P. 136



CRI-97

VIENNA CRI-97
PROIETTORE DA BINARIO
TRACKLIGHT
P. 138



BINARI E ACCESSORI
TRACKLIGHT AND ACCESSORIES
P. 140-143



SISTEMA MODULARE DI BARRE LED T5
T5 LED BARS - MODULAR SYSTEM
P. 144



SHOT S-FLAT LED
P. 145



IP65 IP67

STRIP LED 12V
12V LED STRIP
P. 147



IP65

STRIP LED 24V
24V LED STRIP
P. 148



DRIVER PER STRIP LED
STRIP LED DRIVER
P. 149



MOD-A
MODULO LED CIRCOLARE MAGNETICO DI 2ª GENERAZIONE
SECOND GENERATION MAGNETIC CIRCULAR LED MODULE
P. 150



MOD-B
MODULO LED CIRCOLARE MAGNETICO DI 2ª GENERAZIONE
SECOND GENERATION MAGNETIC CIRCULAR LED MODULE
P. 151

OUTDOOR TECNICO TECHNICAL OUTDOOR



ORLANDO 10
PROIETTORE A LED
LED FLOODLIGHT
P. 154

IP65

IK06



ORLANDO 20 - 20PIR
PROIETTORE A LED
LED FLOODLIGHT
P. 155

IP65

IK06

PIR



ORLANDO 30 - 30PIR
PROIETTORE A LED
LED FLOODLIGHT
P. 156

IP65

IK06

PIR



ORLANDO 50
PROIETTORE A LED
LED FLOODLIGHT
P. 157

IP65

IK06



ORLANDO 90
PROIETTORE A LED
LED FLOODLIGHT
P. 158

IP65

IK06



DENVER
PROIETTORE A LED SLIM
LED SLIM FLOODLIGHT
P. 160

IP65



DENVER
PROIETTORE A LED SLIM CON SENSORE MICROONDE DI MOVIMENTO
SLIM LED FLOODLIGHT WITH MICROWAVE MOTION SENSOR
P. 161

IP44

RADAR



KYOTO 100
PROIETTORE A LED PROFESSIONALE
PROFESSIONAL LED FLOODLIGHT
P. 162

IP66



KYOTO 150
PROIETTORE A LED PROFESSIONALE
PROFESSIONAL LED FLOODLIGHT
P. 163

IP66



KYOTO 200
PROIETTORE A LED PROFESSIONALE
PROFESSIONAL LED FLOODLIGHT
P. 164

IP66



KYOTO 300
PROIETTORE A LED PROFESSIONALE
PROFESSIONAL LED FLOODLIGHT
P. 165

IP66



AKRON
PROIETTORE A LED 12/24V
12/24V LED FLOODLIGHT
P. 166

IP65



STAND PER PROIETTORE - CONNETTORI STAGNI IP68
FLOODLIGHT STAND - IP68 WATERPROOF CONNECTORS
P. 167



CACTUS
PROIETTORE STRADALE A LED
LED STREETLIGHT
P. 168

IP65



PLAFONIERA STAGNA A LED SLIM
SLIM LED TRI-PROOF
P. 170

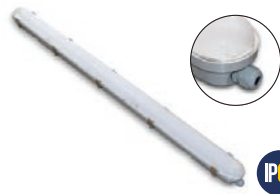

PLAFONIERA STAGNA A LED SLIM - PASSANTE
SLIM TRI-PROOF - PASS THROUGH
P. 171



PLAFONIERA STAGNA A LED SLIM - EMERGENZA
SLIM LED TRI-PROOF - EMERGENCY
P. 172



PLAFONIERA STAGNA A LED SLIM - RADAR
SLIM LED TRI-PROOF - RADAR
P. 173



PLAFONIERA STAGNA A LED - EMERGENZA
LED TRI-PROOF - EMERGENCY
P. 175



PLAFONIERA STAGNA LED
LED TRI-PROOF
P. 176



ACCESSORI PLAFONIERE STAGNE
SCHERMO DI RICAMBIO / CLIPS
LED TRI-PROOF ACCESSORIES
SPARE DIFFUSER / SPARE CLIPS
P. 177



LED HIGH BAY
P. 178



STAFFA - DIFFUSORE 60°/90° PER HIGH BAY LD1HB
BRACKET - DIFFUSER 60°/90° FOR HIGH BAY LD1HB
P. 179



HIGH BAY - LED DOB
P. 180



HIGH BAY LED
ALTA POTENZA
HIGH POWER
P. 181



WORKLIGHT



LAMPADA DA TAVOLO CON LENTE DI INGRANDIMENTO 3D - CLIP DI FISSAGGIO
TABLE LAMP WITH 3D MAGNIFYING LENS - FIXING CLIP
P. 184



LAMPADA DA TAVOLO CON LENTE DI INGRANDIMENTO FISSAGGIO A VITE
TABLE LAMP WITH 3D MAGNIFYING LENS - SCREW FIXING
P. 185



WORK25
PROIETTORE PORTATILE A LED PROFESSIONALE
PROFESSIONAL PORTABLE LED FLOODLIGHT
P. 186



WORK45
PROIETTORE PORTATILE A LED PROFESSIONALE
PROFESSIONAL PORTABLE LED FLOODLIGHT
P. 187



FIORA
LAMPADA A SOSPENSIONE A LED PER CRESCITA PIANTE
LED SUSPENSION LAMP FOR PLANT GROWTH
P. 189



HERBY
LAMPADA DA TAVOLO A LED PER CRESCITA PIANTE
LED TABLE LAMP FOR PLANT GROWTH
P. 191

BOT LIGHTING

FOR A BRIGHT FUTURE



BOT LIGHTING da quasi 40 anni produce e distribuisce in collaborazione con l'azienda Finlandese AIRAM, sorgenti luminose e apparecchi di illuminazione. Con 30 agenzie e circa 2000 distributori capillarmente sparsi in tutto il territorio nazionale è in grado di soddisfare le diversificate esigenze del consumatore.

In un mercato in continuo movimento, Bot Lighting ha raccolto la sfida con un'attenzione assidua all'innovazione tecnologica e al design, con forme eleganti ed essenziali di alta qualità. Il comparto logistico è in grado di offrire un servizio in tempo reale, il tutto ben assistito da una politica commerciale trasparente e mirata alla distribuzione. Competenza, professionalità e dinamismo, sono le qualità che hanno permesso d'instaurare con il cliente un rapporto privilegiato di reciproca crescita.

Bot Lighting propone un'ampia gamma di sorgenti luminose e apparecchi di illuminazione per uso civile ed industriale.

Con i marchi SHOT, AIRAM e KAI: sorgenti led, apparecchi indoor & outdoor a led, lampade a scarica, lampade ad incandescenza, alogene, a risparmio energetico compatte non integrate, reattori e starter, pile elettriche, tubi fluorescenti e apparecchi portatili luminosi per il fai da te. Il packaging oltre all'aspetto cromatico molto accattivante, punta soprattutto alla facile comprensione da parte dell'utente finale.

BOT LIGHTING has been producing and distributing lighting and light fittings in partnership with the Finnish company AIRAM for almost 40 years. With 30 agencies and approximately 2000 distributors throughout Italy, it is able to satisfy a wide range of consumer needs.

Bot Lighting has met the challenge of an ever-evolving market environment through a steadfast approach to technological innovation and design to create elegant and essential styles of the highest quality. The logistics department is equipped to offer a real-time service, supported by a transparent sales strategy aimed at ensuring efficient distribution. Competence, professionalism and dynamism are the key qualities that have fostered the development of beneficial client relationships based on mutual growth.

Bot Lighting offers a wide range of lighting and light fittings for both domestic and industrial use.

Available with the SHOT, AIRAM and KAI brands: LED lighting, indoor & outdoor LED light fittings, discharge lamps, incandescent lamps, halogen lamps, compact and non integrated energy saving lamps, ballasts and starters, batteries, fluorescent tubes and portable lighting devices for DIY use. As well as being extremely attractive with its colour scheme, the packaging is specifically designed to be easy to understand for the end user.

BOT LIGHTING fertigt und vertreibt in Zusammenarbeit mit dem finnischen Unternehmen AIRAM seit fast 40 Jahren Lichtquellen und Leuchten. Mit 30 Agenturen und ca. 2000 Vertriebspartnern, die engmaschig über das gesamte Territorium verteilt sind, können die unterschiedlichsten Anforderungen des Konsumenten erfüllt werden.

Bot Lighting hat sich in einem in ständigem Wandel befindlichen Markt der Herausforderung gestellt und seinen Fokus auf technologische Innovation und Design mit eleganten und essentiellen Linien hochwertiger Qualität gelegt.

Die Logistikabteilung ist in der Lage, Dienstleistungen in Echtzeit zu bieten. Hierbei wird sie von einer transparenten und auf gezielte Verteilung basierenden Handelspolitik unterstützt. Kompetenz, Professionalität und Dynamismus sind die Stärken, die dazu beigetragen haben, eine auf gegenseitigem Wachstum basierende Vertrauensbeziehung mit dem Kunden aufzubauen.

Bot Lighting bietet eine umfangreiche Produktpalette an Lichtquellen und Leuchten für den zivilen und industriellen Gebrauch. Mit den Marken SHOT, AIRAM und KAI: LED-Lichtquellen, LED-Leuchten für den Innen- und Außenbereich, Entladungslampen, Glühlampen, Halogenlampen, kompakte und nicht integrierte Energiesparlampen, Vorschalt- und Startgeräte, elektrische Batterien, Leuchtstoffröhren und tragbare Leuchten für Heimwerker.

Das Packaging ist neben dem sehr ansprechenden farblichen Aspekt auf leichte Verständlichkeit für den Endbenutzer ausgelegt.

Desde hace casi 40 años, **BOT LIGHTING** produce y distribuye, en colaboración con la empresa finlandesa AIRAM, fuentes de luz y luminarias. Con 30 agencias y alrededor de 2000 distribuidores repartidos en todo el territorio italiano, satisface las diferentes necesidades del consumidor. Bot Lighting ha enfrentado el desafío de un mercado en constante movimiento con un enfoque resuelto hacia la innovación tecnológica y el diseño, con formas elegantes y esenciales de la más alta calidad.

La división logística ofrece un servicio en tiempo real, respaldado por una política comercial transparente que se dedica a ofrecer una distribución eficiente. La competencia, profesionalidad y dinamismo son las cualidades que nos han permitido establecer una relación privilegiada con el cliente, fundada sobre el crecimiento mutuo.

Bot Lighting ofrece una amplia gama de fuentes de iluminación y luminarias para uso civil e industrial.

Disponibles con las marcas SHOT, AIRAM y KAI: luces Led, luminarias de Led para interiores y exteriores, lámparas de descarga, lámparas incandescentes, halógenas, bombillas de bajo consumo compactas y no integradas, balastos y arrancadores, linternas, tubos fluorescentes y equipos portátiles de iluminación para bricolaje. El embalaje, además de ser muy atractivo por sus colores, está diseñado específicamente para que resulte de fácil comprensión para el usuario final.

SHOT è oggi punto di riferimento nel settore dell'illuminotecnica.

Un'offerta vastissima connotata da una forte differenziazione di gamme e soluzioni, tutte accomunate dai principi e dai valori essenziali su cui si fonda la mission e l'approccio del brand: evoluzione tecnica costante, efficienza, risparmio energetico, ecocompatibilità. Ricerca del livello di comfort ideale in termini di ergonomia e praticità, ottimo rapporto qualità/prezzo.

Perseguendo questi obiettivi Bot Lighting ha acquisito negli anni posizioni sempre più rilevanti sul mercato e le ha mantenute grazie a una politica aziendale ambiziosa e determinata: un marketing aggressivo nel monitorare bisogni e segnali di cambiamento, un prodotto flessibile per riuscire a interpretarne la variabilità, una logistica articolata, per offrire un servizio sempre efficiente e tempestivo.

SHOT, setting the standard in today's lighting sector.

A vast array of products characterised by a wide variety of ranges and solutions, all encompassing the key principles and values on which the brand's mission and approach are based: constant technological evolution, efficiency, energy saving, eco-friendliness. The pursuit for the ultimate level of customer satisfaction in terms of ergonomics, convenience and value for money.

In pursuing these objectives Bot Lighting has, over the years, secured an ever more significant position within the market, a position it has maintained thanks to its ambitious and clearly defined business strategy: aggressive marketing to fully understand the needs of the market and any signs of change, a flexible product able to respond to that variability, and well-organised logistics to offer an efficient and timely service.

SHOT, SETTING THE STANDARD IN TODAY'S LIGHTING SECTOR

SHOT zählt heute als Maßstab im Bereich der Beleuchtungstechnik.

Ein umfassendes Angebot mit vielfältigen Produktlinien und Lösungen, die alle dieselben Prinzipien und grundlegenden Werte verfolgen, auf denen die Mission und der Ansatz der Marke basiert: fortlaufende technische Weiterentwicklung, Effizienz, Energieeinsparung, Umweltfreundlichkeit. Suche nach dem idealen Komfortniveau in Bezug auf Ergonomie und praktische Handhabung, gutes Preis-Leistungs-Verhältnis.

Die Verfolgung all dieser Zielsetzungen hat dazu geführt, dass Bot Lighting in den letzten Jahren eine immer bedeutendere Position am Markt einnehmen und diese dank einer ehrgeizigen und entschlossenen Geschäftspolitik beibehalten konnte: ein aktiv betriebenes Marketing zur Sondierung der Bedürfnisse und der Zeichen der Veränderung, ein flexibles Produkt, um dessen Veränderlichkeit zu interpretieren, eine ausgereifte Logistik für einen stets effizienten und zeitnahen Service.

SHOT es hoy un punto de referencia en el sector de la luminotecnica.

Una oferta dilatada de productos que se caracteriza por una fuerte diferenciación de las gamas y soluciones que comparten los principios y valores esenciales sobre los que se basa la misión y el enfoque de la marca: la constante evolución técnica, eficiencia, ahorro de energía y compatibilidad ecológica. La búsqueda del nivel ideal de comodidad en términos de ergonomía y practicidad y una excelente relación calidad/precio.

Con la determinación de alcanzar estos objetivos, Bot Lighting ha adquirido en los últimos años una posición cada vez más importante en el mercado, que ha mantenido gracias a una ambiciosa y clara política de la empresa: un marketing agresivo para comprender en profundidad las necesidades del mercado y cada señal de cambio, un producto flexible que es capaz de responder a esa variabilidad, una logística bien organizada, para ofrecer un servicio eficiente y oportuno.



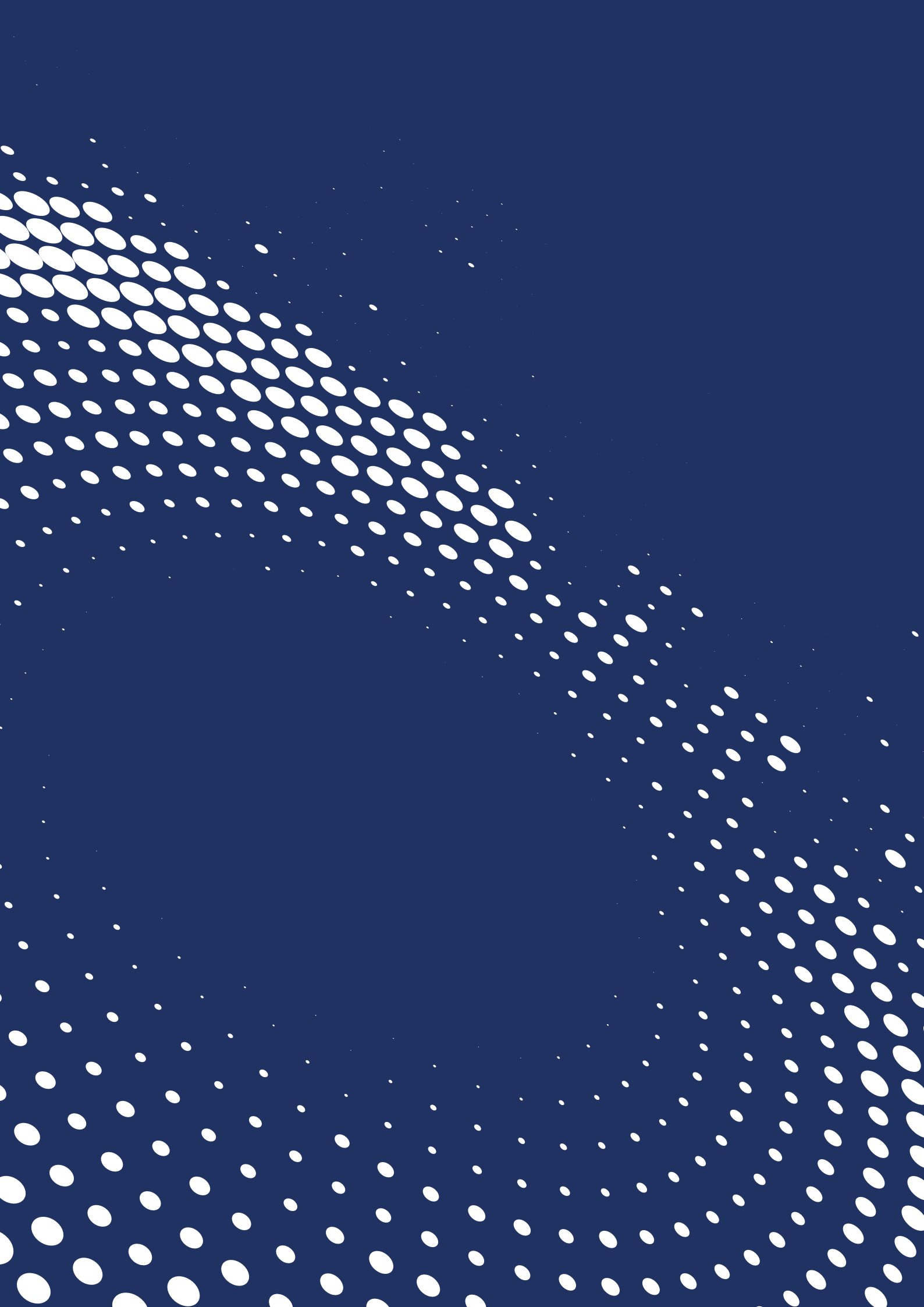

A decorative graphic in the bottom-left corner consisting of a series of white dots of varying sizes, arranged in a pattern that suggests a fan or a cluster of particles.

INDOOR RESIDENZIALE
RESIDENTIAL INDOOR



IT

Disegnata da Tapio Wirkkala per Airam nel 1959, la lampada WIR fu una novità nel design delle lampade.

A questa lampada elegante con il suo vetro opale e il suo portalampada semplificato venne assegnato il premio Grand Prix alla XII Triennale di Milano nel 1960. La lampada divenne immediatamente un successo internazionale.

Più avanti Wirkkala progettò una gamma completa di apparecchi di illuminazione: una serie di lampade in vetro colorato che potessero non solo esaltare la luce piacevole e la forma della lampadina, ma anche aggiungere varietà alla loro semplice eleganza.

EN

Designed by Tapio Wirkkala for Airam in 1959, the WIR lamp was a novelty in lamp design.

This elegant lamp with its opal glass and simplified lamp holder was awarded the Grand Prix prize at the 12th Milan Triennale in 1960.

The lamp immediately became an international success.

Later Wirkkala designed a complete range of luminaires: a series of colored glass lamps that could not only enhance the pleasant light and shape of the bulb, but also add variety to their simple elegance.

WIRKKALA K2-142

LAMPADA A SOSPENSIONE LED DIMMERABILE
DIMMABLE LED PENDANT LAMP



12^a
Triennale
di Milano

diploma di gran premio

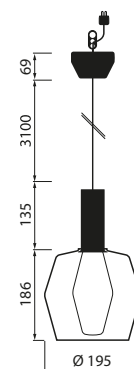

IT

- Lampada a sospensione in vetro disegnata da Tapio Wirkkala, premiata per il design della lampada WIR alla XII triennale di Milano (1960)
- Monta una lampada WIR-85 dimmerabile con attacco E27 (inclusa)
- Disponibile con vetro in 4 colorazioni
- Compatibile con CEILING CUP e CEILING BAR per composizione di tre o quattro elementi

EN

- Glass pendant light designed by Tapio Wirkkala, awarded for the design of the WIR bulb at the XII Triennale exhibition of Milan (1960)
- Requires a dimmable WIR-85 bulb with E27 base (included)
- Glass shade available in 4 colours
- Compatible with CEILING CUP and CEILING BAR for three or four-light cluster



POTENZA WATT	BASE	KELVIN	LUMEN LM	FAŠCIO °	MISURE MM	VARIANTE	CODICE	EAN	IMBALLO	€ IVA ESCLUSA
8	E27	3000	760	360	1	BLU FUME' / SMOKED BLUE	4126206	6435200234636	1/4	-
8	E27	3000	760	360	1	GRIGIO VERDE / GREENISH GREY	4126207	6435200234650	1/4	-
8	E27	3000	760	360	1	SABBIA / SAND	4126208	6435200234674	1/4	-
8	E27	3000	760	360	1	TRASPARENTE / CLEAR	4126268	6435200247087	1/4	-

WIRKKALA K2-135

 LAMPADA A SOSPENSIONE LED DIMMERABILE
 DIMMABLE LED PENDANT LAMP

IT

- Lampada a sospensione in vetro disegnata da Tapio Wirkkala, premiato per il design della lampada WIR alla XII triennale di Milano (1960)
- Monta una lampada WIR-85 dimmerabile con attacco E27 (inclusa)
- Disponibile con vetro in 4 colorazioni
- Compatibile con CEILING CUP e CEILING BAR per composizione di tre o quattro elementi

EN

- Glass pendant light designed by Tapio Wirkkala, awarded for the design of the WIR bulb at the XII Triennale exhibition of Milan (1960)
- Requires a dimmable WIR-85 bulb with E27 base (included)
- Glass shade available in 4 colours
- Compatible with CEILING CUP and CEILING BAR for three or four-light cluster



POTENZA WATT	BASE	KELVIN	LUMEN LM	FASCIO °	MISURE MM	VARIANTE	CODICE	EAN	IMBALLO	€ IVA ESCLUSA
8	E27	3000	760	360	1	BLU FUME' / SMOKED BLUE	4126209	6435200234698	1/4	-
8	E27	3000	760	360	1	GRIGIO VERDE / GREENISH GREY	4126210	6435200234711	1/4	-
8	E27	3000	760	360	1	SABBIA / SAND	4126211	6435200234735	1/4	-
8	E27	3000	760	360	1	TRASPARENTE / CLEAR	4126267	6435200247063	1/4	-

WIRKKALA K2-140

LAMPADA A SOSPENSIONE LED DIMMERABILE
DIMMABLE LED PENDANT LAMP

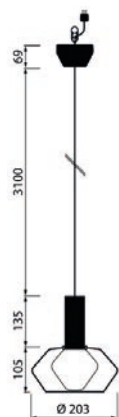

IT

- Lampada a sospensione con corpo in acciaio satinato disegnata da Tapio Wirkkala.
- Cavo di alimentazione traslucido e paralume in vetro trasparente.
- Monta una lampadina WIR-105 dimmerabile con attacco E27 (inclusa)
- Compatibile con CEILING CUP e CEILING BAR per composizione di tre o quattro elementi

EN

- Brushed stainless steel pendant designed by Tapio Wirkkala
- Clear glass shade and translucent power cord
- Requires a dimmable WIR-105 bulb with E27 base (included)
- Compatible with CEILING CUP and CEILING BAR for three or four-light cluster

POTENZA WATT	BASE	KELVIN	LUMEN LM	FASCIO °	MISURE MM	VARIANTE	CODICE	EAN	IMBALLO	€ IVA ESCLUSA
6	E27	3000	470	360	1	TRASPARENTE / CLEAR	4126269	6435200247100	1/4	-

WIR LAMPPU K2-131

 LAMPADA A SOSPENSIONE LED DIMMERABILE
 DIMMABLE LED PENDANT LAMP

IT

- Lampada a sospensione con corpo nero disegnata da Tapio Wirkkala nel 1959 e premiata alla XII Triennale di Milano nel 1960.
- Monta una lampadina WIR-85 dimmerabile con attacco E27 (inclusa)
- Compatibile con CEILING CUP e CEILING BAR per composizione di tre o quattro elementi

EN

- Pendant light with black body designed by Tapio Wirkkala in 1959, awarded for the design at the XII Triennale exhibition of Milan in 1960
- Requires a dimmable WIR-85 bulb with E27 base (included)
- Compatible with CEILING CUP and CEILING BAR for three or four-light cluster



POTENZA WATT	BASE	KELVIN	LUMEN LM	FASCIO °	MISURE MM	VARIANTE	CODICE	EAN	IMBALLO	€ IVA ESCLUSA
8	E27	3000	760	360	1	-	4126212	6435200234759	1/6	-

WIR LAMPPU K2-80 KRS

LAMPADA A SOSPENSIONE LED DIMMERABILE
DIMMABLE LED PENDANT LAMP

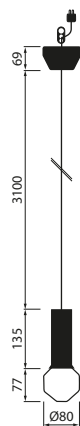

IT

- Lampada a sospensione con corpo in acciaio satinato disegnata da Tapio Wirkkala nel 1968.
- Monta una lampadina WIR-80 KRS dimmerabile con attacco E27 (inclusa)
- Compatibile con CEILING CUP e CEILING BAR per composizione di tre o quattro elementi

EN

- Brushed stainless steel pendant designed by Tapio Wirkkala in 1968
- Requires a dimmable WIR-80 KRS bulb with E27 base (included)
- Compatible with CEILING CUP and CEILING BAR for three or four-light cluster



POTENZA WATT	BASE	KELVIN	LUMEN LM	FASCIO °	MISURE MM	VARIANTE	CODICE	EAN	IMBALLO	€ IVA ESCLUSA
3,5	E27	2500	280	360	1	-	4126270	6435200247124	1/6	-

WIR LAMPPU K2-105

 LAMPADA A SOSPENSIONE LED DIMMERABILE
 DIMMABLE LED PENDANT LAMP

IT

- Lampada a sospensione con corpo nero disegnata da Tapio Wirkkala
- Monta una lampadina WIR-105 dimmerabile con attacco E27 (inclusa)
- Compatibile con CEILING CUP e CEILING BAR per composizione di tre o quattro elementi

EN

- Pendant light with black body designed by Tapio Wirkkala
- Requires a dimmable WIR-105 bulb with E27 base (included)
- Compatible with CEILING CUP and CEILING BAR for three or four-light cluster



POTENZA WATT	BASE	KELVIN	LUMEN LM	FASCIO °	MISURE MM	VARIANTE	CODICE	EAN	IMBALLO	€ IVA ESCLUSA
6	E27	3000	470	360	1	-	4126271	6435200247148	1/6	-

WIR-85

LAMPADINA A LED DIMMERABILE
DIMMABLE LED LIGHT BULB

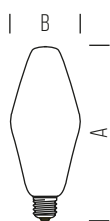

DIMENSIONI	A	B
1	206	85



15.000 H



100.000

POTENZA WATT	BASE	KELVIN	LUMEN LM	FASCIO °	MISURE MM	VARIANTE	CODICE	EAN	IMBALLO	€ IVA ESCLUSA
8	E27	3000	760	360	1	-	4711789	6435200231840	1/6	-

WIR-105

LAMPADINA A LED DIMMERABILE
DIMMABLE LED LIGHT BULB

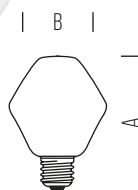

DIMENSIONI	A	B
1	143	105



15.000 H



100.000

POTENZA WATT	BASE	KELVIN	LUMEN LM	FASCIO °	MISURE MM	VARIANTE	CODICE	EAN	IMBALLO	€ IVA ESCLUSA
6	E27	3000	470	360	1	-	406505	6435200179487	1/6	-

WIR-80 KRS

LAMPADINA A LED DIMMERABILE
DIMMABLE LED LIGHT BULB

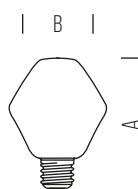

DIMENSIONI	A	B
1	119	80



15.000 H



100.000

POTENZA WATT	BASE	KELVIN	LUMEN LM	FASCIO °	MISURE MM	VARIANTE	CODICE	EAN	IMBALLO	€ IVA ESCLUSA
3,5	E27	2500	280	360	1	-	4711766	6435200231109	1/6	-

CEILING BAR
PER LAMPADA WIRKKALA
FOR WIRKKALA LAMP

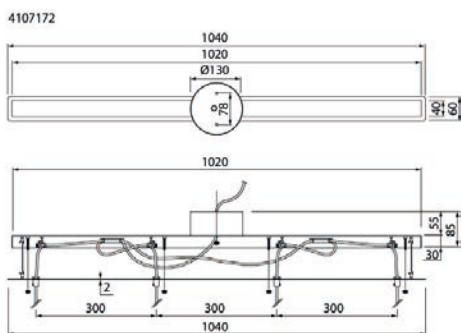
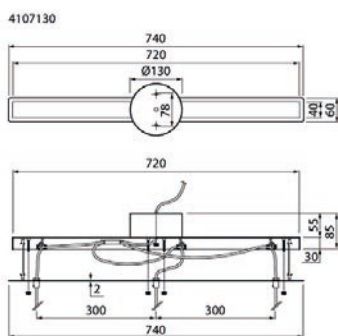

IT

- Corpo in acciaio inossidabile con finitura spazzolata
- Disponibile in due misure: per tre o quattro pendant, distanziati tra loro di 300mm
- Lunghezza del cavo selezionabile per ogni pendant

EN

- Brushed stainless steel body
- Available in two sizes: for three or four pendant spaced 300mm each other
- Selectable cable length for each pendant

POTENZA WATT	BASE	KELVIN	LUMEN LM	FASCIO °	MISURE MM	VARIANTE	CODICE	EAN	IMBALLO	€ IVA ESCLUSA
-	-	-	-	-	1	3 PENDANT	4107130	6435200258595	1/4	-
-	-	-	-	-	2	4 PENDANT	4107172	6435200258618	1/4	-

CEILING CUP
PER LAMPADA WIRKKALA
FOR WIRKKALA LAMP

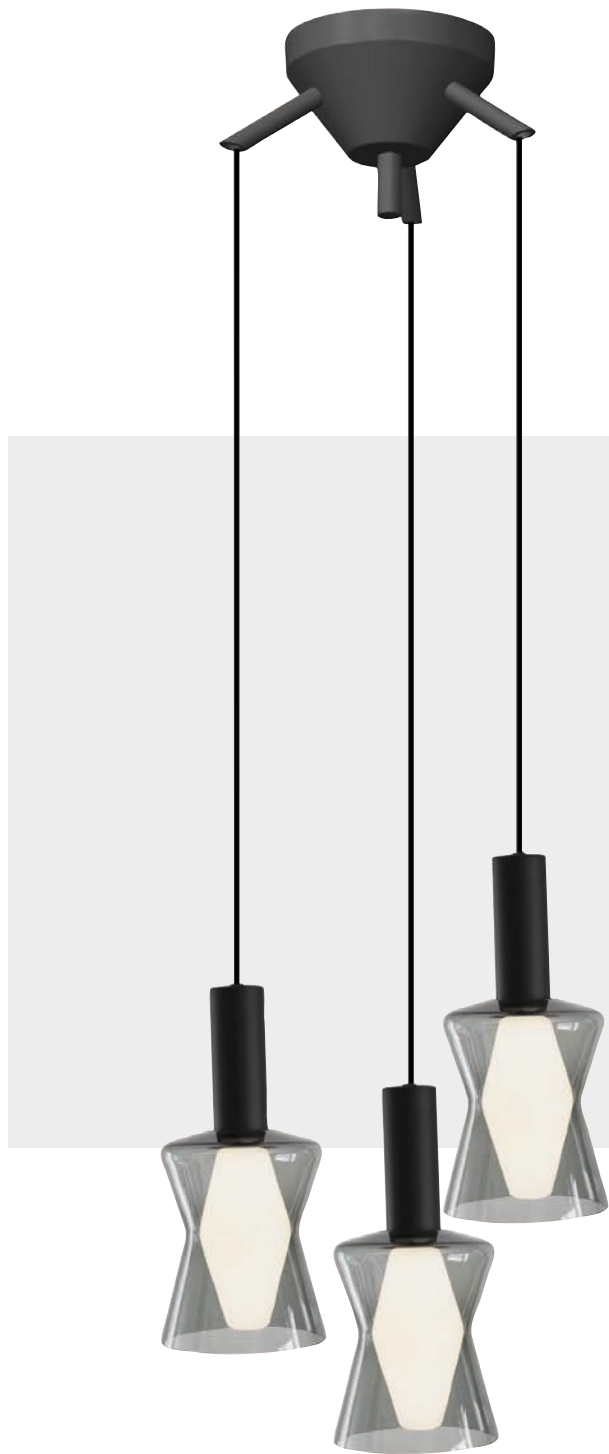
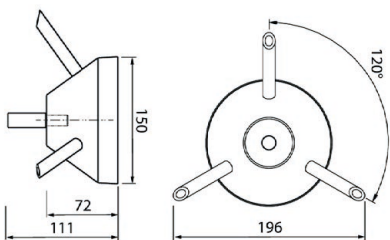

VARIANTE	CODICE	EAN	IMBALLO	€ IVA ESCLUSA
NERO / BLACK	4126256	6435200241382	1	-
BIANCO / WHITE	4126276	6435200247568	1	-
ACCIAIO SATINATO / SATIN STEEL	4126277	6435200247582	1	-



LOFT35
LAMPADA A SOSPENSIONE
PENDANT LAMP

BTL CATEGORIA SCONTO 23

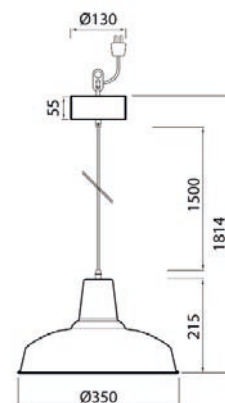

IT

- Incluso cavo da 1,5 metri e coppa da soffitto
- Monta una sorgente led con attacco E27 – 60W max. (non inclusa)

EN

- Supplied with 1.5-metre black fabric power cord and ceiling cup
- Requires a LED light source with E27 base – 60W max. (not included)



POTENZA WATT	BASE	KELVIN	LUMEN LM	FASCIO °	MISURE MM	VARIANTE	CODICE	EAN	IMBALLO	€ IVA ESCLUSA
-	E27	-	-	-	1	BIANCO / WHITE	9783080	6435200235985	1	56,18
-	E27	-	-	-	1	NERO / BLACK	9783081	6435200236005	1	56,18



SANSA
LAMPADA A SOSPENSIONE
PENDANT LAMP

BTL CATEGORIA SCONTO 23

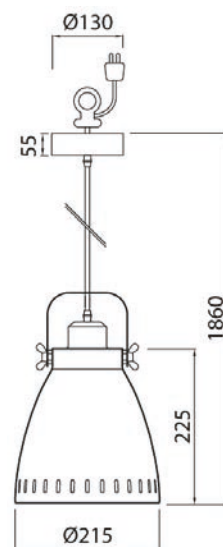

IT

- Incluso cavo da 1,5 metri e coppa da soffitto
- Monta una sorgente led con attacco E27 – 40W max. (non inclusa)

EN

- Supplied with 1.5-metre black fabric power cord and ceiling cup
- Requires a LED light source with E27 base – 40W max.
- (not included)



POTENZA WATT	BASE	KELVIN	LUMEN LM	FASCIO °	MISURE MM	VARIANTE	CODICE	EAN	IMBALLO	€ IVA ESCLUSA
-	E27	-	-	-	1	BIANCO / WHITE	4118754	6435200226525	1/6	56,18
-	E27	-	-	-	1	GRIGIO / GREY	4126224	6435200238184	1/6	56,18
-	E27	-	-	-	1	NERO / BLACK	4126225	6435200238207	1/6	56,18

CARA

APPLIQUE CON FISSAGGIO A CLIP
CLIP WALL LAMP

NEW

BTL CATEGORIA SCONTO 23

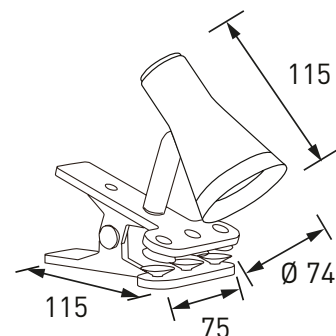

IT

- Elegante applique con sistema di aggancio a clip dall'aspetto moderno per interni.
- Fascio orientabile grazie allo snodo presente nello stelo.
- Interruttore su cavo.

EN

- Elegant table lamp with a modern look for indoors.
- Adjustable beam thanks to the joint in the stem.
- Switch on cable.

IP20
 **220v
240v**
25.000 H
0° +40°

POTENZA WATT	BASE	KELVIN	LUMEN LM	MISURE MM	VARIANTE	CODICE	EAN	IMBALLO	€ IVA ESCLUSA
4,5	-	3000	320	1	BIANCO / WHITE	9610414	6435200271938	1	39,10

CARA
APPLIQUE
WALL LAMP

NEW

BTL CATEGORIA SCONTO 23

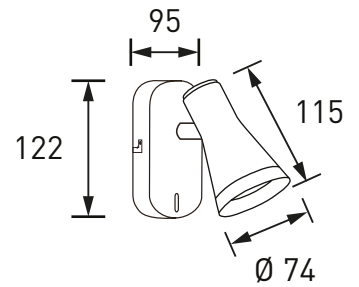

IT

- Elegante applique dall'aspetto moderno per interni.
- Fascio orientabile grazie allo snodo presente nello stelo.
- Interruttore su corpo lampada.

EN

- Elegant table lamp with a modern look for indoors.
- Adjustable beam thanks to the joint in the stem.
- Switch on the body.



POTENZA WATT	BASE	KELVIN	LUMEN LM	MISURE MM	VARIANTE	CODICE	EAN	IMBALLO	€ IVA ESCLUSA
4,5	-	3000	320	1	BIANCO / WHITE	96 104 15	6435200271976	1	37,50

CARA
LAMPADA DA TAVOLO
TABLE LAMP

NEW

BTL CATEGORIA SCONTO 23

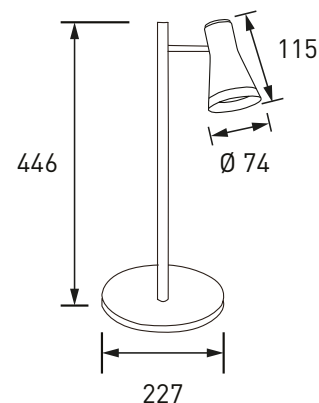

IT

- Elegante lampada da tavolo dall'aspetto moderno per interni.
- Fascio orientabile grazie allo snodo presente nello stelo.

EN

- Elegant table lamp with a modern look for indoors.
- Adjustable beam thanks to the joint in the stem.



POTENZA WATT	BASE	KELVIN	LUMEN LM	MISURE MM	VARIANTE	CODICE	EAN	IMBALLO	€ IVA ESCLUSA
4,5	-	3000	320	1	BIANCO / WHITE	9610413	6435200271891	1	51,20



GILDA

LAMPADA DA TAVOLO CON DIMMER
TABLE LAMP WITH DIMMER

BTL CATEGORIA SCONTO 23

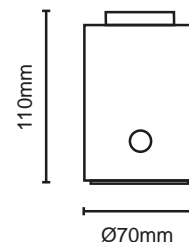

GILDAB



GILDAP



GILDAS



Globo 125 LED SPRING Dimmable

Disponibile nel nostro catalogo Botlighting "sorgenti e accessori"

Available on our Botlighting "light sources and accessories"

IT

- Lampada da tavolo con attacco E27 Max 60W - cavo 1,5mt (lampadina non inclusa).
- Regolazione dell'intensità luminosa tramite smooth dimmer.
- Disponibile nei colori nero opaco, nero perla e metallo spazzolato.
- Sugerito l'utilizzo con le nostre GLOBO 125 LED SPRING dimmerabili - catalogo sorgenti ed accessori:
5,0W / E27 / 1800K / 300lm / A+ 330 / art. WLD4005X2HSDW
5,0W / E27 / 2700K / 400lm / A+ 330 / art. WLD4005X2HSD

EN

- Table lamp with E27 socket Max 60W - Cable 1,5mt (bulb not included).
- Adjustable light level with smooth dimmer.
- Available in matt black, pearl black and brushed metal.
- Recommended for use with our GLOBO 125 LED SPRING dimmable - sources and accessories catalog:
5,0W / E27 / 1800K / 300lm / A+ 330 / art. WLD4005X2HSDW
5,0W / E27 / 2700K / 400lm / A+ 330 / art. WLD4005X2HSD



POTENZA WATT	BASE	KELVIN	LUMEN LM	MISURE MM	VARIANTE	CODICE	EAN	IMBALLO	€ IVA ESCLUSA
-	-	-	-	1	NERO OPACO / MATT BLACK	GILDAB	8031453024611	1	41,34
-	-	-	-	1	NERO PERLA / PEARL BLACK	GILDAP	8031453024628	1	41,34
-	-	-	-	1	METALLO SPAZZOLATO / BRUSHED METAL	GILDAS	8031453024635	1	41,34



ILLUSION
LAMPADA DA TAVOLO LED
LED TABLE LAMP

BTL CATEGORIA SCONTO 23

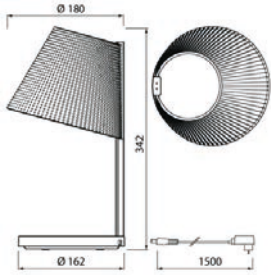

Grafica / graphic: "Dot"



Grafica / graphic: "Line"



reddot award 2019
winner lighting design

IT

- Regolazione dell'intensità luminosa tra 5 step, dal 10% di luminosità fino al 100%.
- Regolazione della temperatura di colore tra 5 step: 2500/2900/3300/3900/4300 K.
- Ricarica wireless rapida di tutti i dispositivi compatibili con lo standard Qi
- Base di ricarica in vetro temperato di sicurezza resistente all'usura.
- Tasti di selezione luminosità, temperatura di colore e accensione/spegnimento a sfioramento
- Accensione/spegnimento della lampada mediante il passaggio della mano sopra il paralume tramite sensore a infrarossi.

EN

- Adjustable light level in 5 steps from 10% to 100%
- Adjustable color temperature in 5 steps: 2500/2900/3300/3900/4300 K
- Wireless fast charging of all Qi-compatible devices
- The charger base is made of wear-resistant and safe tempered glass.
- Touch switches for colour temperature and brightness adjustment.
- Power ON and OFF passing the hand over the lampshade via infrared sensor



POTENZA WATT	BASE	KELVIN	LUMEN LM	FASCIO °	MISURE MM	VARIANTE	CODICE	EAN	IMBALLO	€ IVA ESCLUSA
7	-	2500 4300	310	360	1	DOT	4126297	6435200255556	1/4	-
7	-	2500 4300	240	360	1	LINE	4126298	6435200255570	1/4	-

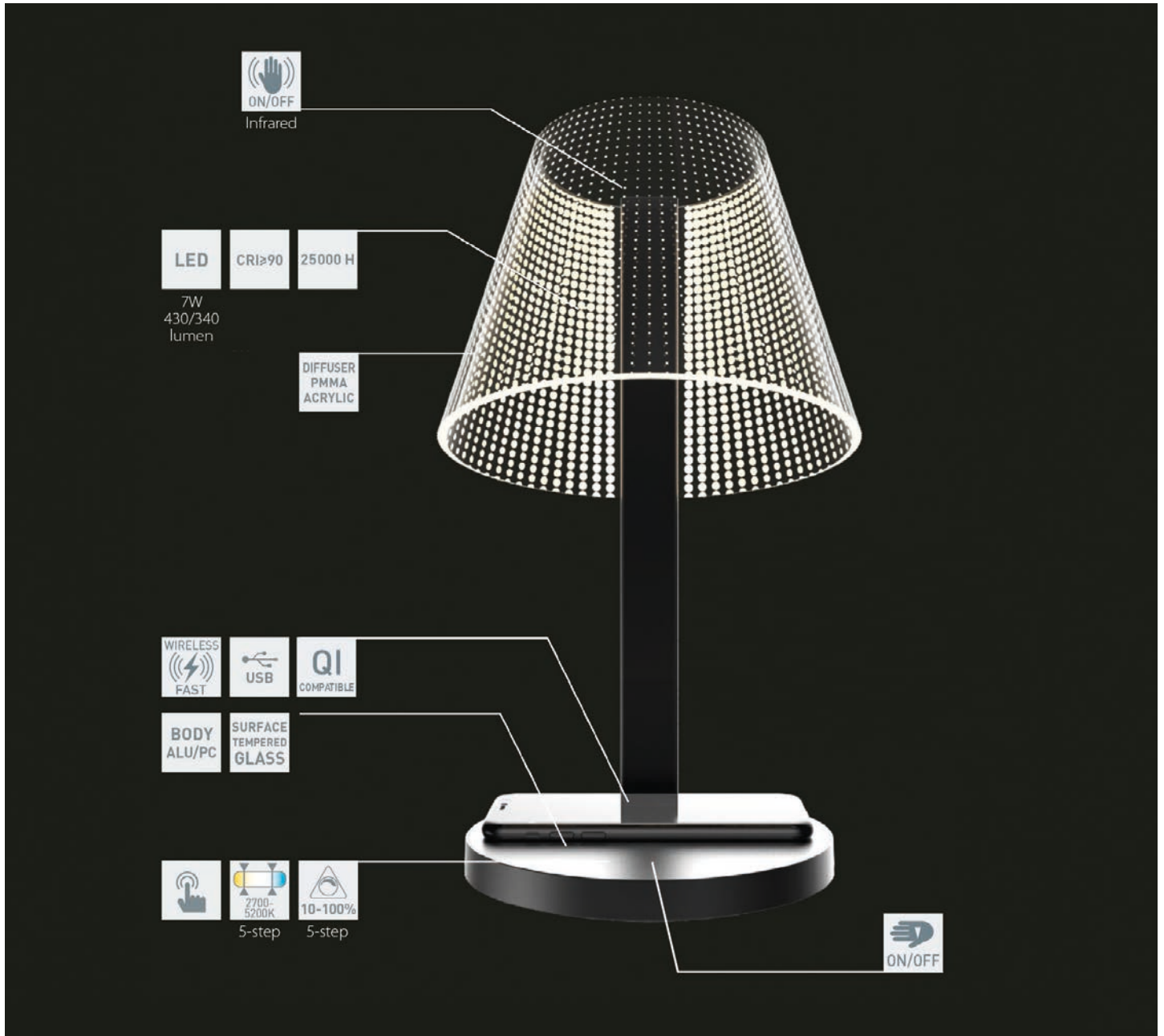



LIV DESK
LAMPADA DA TAVOLO
TABLE LAMP

BTL CATEGORIA SCONTO 23

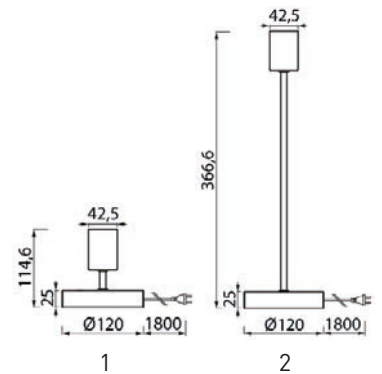

IT

- Versione con altezza 15cm o 30cm
- Incluso cavo rivestito in tessuto da 1,8 metri e presa
- Monta una sorgente led con attacco E27 - 40W max. (non inclusa)

EN

- Available in 2 heights 15cm and 30cm
- Supplied with 1.5-metre fabric power cord and plug
- Requires a LED light source with E27 base - 40W max. (not included)



POTENZA WATT	BASE	KELVIN	LUMEN LM	FASCIO °	MISURE MM	VARIANTE	CODICE	EAN	IMBALLO	€ IVA ESCLUSA
-	E27	-	-	-	1	BIANCO / WHITE	4126241	6435200240675	1/6	25,44
-	E27	-	-	-	1	NERO / BLACK	4126242	6435200240699	1/6	25,44
-	E27	-	-	-	1	ACCIAIO SPAZZOLATO / BRUSHED STEEL	4126243	6435200240712	1/6	25,44
-	E27	-	-	-	2	BIANCO / WHITE	4126244	6435200240736	1/6	30,74
-	E27	-	-	-	2	NERO / BLACK	4126245	6435200240750	1/6	30,74
-	E27	-	-	-	2	ACCIAIO SPAZZOLATO	4126246	6435200240774	1/6	30,74



NITA DESK
LAMPADA DA TAVOLO
TABLE LAMP

BTL CATEGORIA SCONTO 23

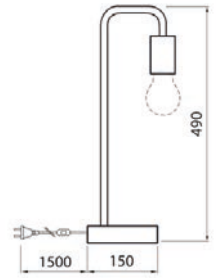

IT

- Incluso cavo da 1,5 metri, presa e interruttore on/off
- Monta una sorgente led con attacco E27 – 40W max. (non inclusa)

EN

- Supplied with 1.5-metre power cord with plug and on/off switch
- Requires a LED light source with E27 base – 40W max. (not included)



POTENZA WATT	BASE	KELVIN	LUMEN LM	FASCIO °	MISURE MM	VARIANTE	CODICE	EAN	IMBALLO	€ IVA ESCLUSA
-	E27	-	-	-	1	BIANCO / WHITE	9783077	6435200235923	1/6	38,16
-	E27	-	-	-	1	NERO / BLACK	9783078	6435200235947	1/6	38,16

GIADA

PLAFONIERA AD ALTA RESISTENZA IMPERMEABILE
HIGH RESISTANCE & WATERPROOF CEILING LIGHT

BTL CATEGORIA SCONTO 23

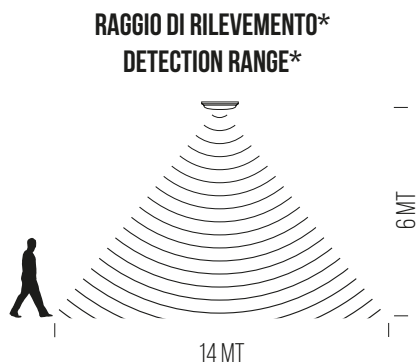
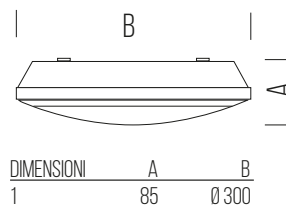

Predisposto per terminali IP65
optional (non inclusi)

IP65 connection terminal is
optional (not included)



Fori posteriori per
inserimento cavo loop in /
loop out compatibile con
connessioni da 68/78mm

Holes at the back side
of housing for loop in/
loop out. Compatible with
68/78mm junction box

IT

- Plafoniera in policarbonato ad alta resistenza IK10
- Alta efficienza fino a 115 lm/W
- Flicker-Free
- Ghiera bloccabile con brugola antivandalismo, schermo fissato con viti (non visibili)
- Doppio foro di ingresso per collegamento in/out
- Predisposizione collegamento passante sui lati
- **Disponibile anche in variante con modulo emergenza 3h di durata a 150 lm**
- **Disponibile anche in variante con sensore microonde** programmabile mediante dip-switch (sensibilità, livello di luce ambiente, durata)

EN

- IK10 high resistance polycarbonate ceiling light
- High efficiency up to 115 lm/W
- Flicker-Free
- Lockable ring with vandal-proof Allen key, screen fixed with screws (not visible)
- Double input hole for in / out connection
- Predisposition for through connection on the sides
- **Also available with 3h lasting emergency module at 150 lm**
- **Also available with microwave sensor** programmable by dip-switch (sensitivity, ambient light level, duration)

IP65 **IK10** **50.000 H** **INSTANT** **CLASS II** **-20°/+40°** **220V/240V** **NOT DIMMABLE**
RADAR **ON** **m** **EMERGENCY** **3 H** **150 LM**

POTENZA WATT	BASE	KELVIN	LUMEN LM	FASCIO °	MISURE MM	VARIANTE	CODICE	EAN	IMBALLO	€ IVA ESCLUSA
15,0	-	4000	1700	120	1	ON/OFF	GIADA153	8031453023645	1/5	51,94
17,0	-	4000	1700	120	1	EMERGENZA / EMERGENCY	GIADA153E	8031453023652	1/5	120,84
16,0	-	4000	1700	120	1	MICROWAVE SENSOR*	GIADA153S	8031453023669	1/5	79,50
25,0	-	4000	2800	120	1	ON/OFF	GIADA253	8031453023676	1/5	56,18

GIADA
ACCESSORI
ACCESSORIES

BTL CATEGORIA SCONTO 23

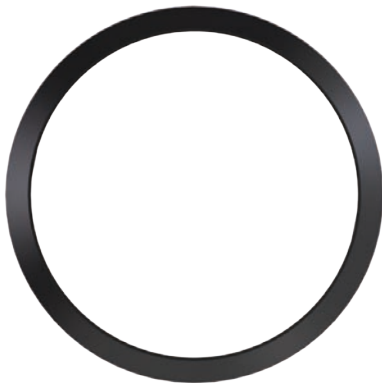

Anello / Ring
GIADAT0B

IT

Gli accessori GIADA permettono la personalizzazione estetica del prodotto conferendogli un look più adatto allo stile dell'ambiente.

EN

GIADA accessories allow the aesthetic personalization of the product, giving it a better look based to the style of the environment.

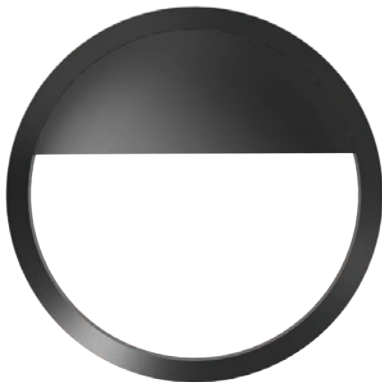

Anello con copertura / ring with cover
GIADAT1B



Anello con copertura / ring with cover
GIADAT1W

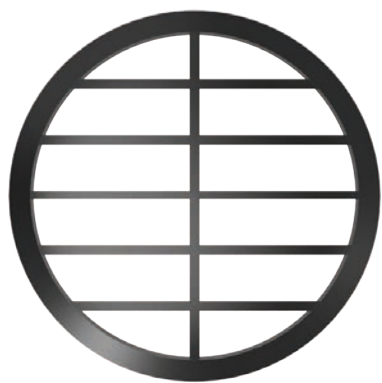

Anello con griglia / ring with grid
GIADAT2B



Anello con griglia / ring with grid
GIADAT2W

ACCESSORIO	VARIANTE	CODICE	EAN	IMBALLO	€ IVA ESCLUSA
ANELLO NERO / BLACK RING	ANELLO / RING	GIADAT0B	8031453023683	1	6,36
ANELLO CON COPERTURA NERO / RING WITH BLACK COVER	70/30	GIADAT1B	8031453023690	1	7,95
ANELLO CON GRIGLIA NERO / RING WITH BLACK GRID	GRIGLIA / GRID	GIADAT2B	8031453023713	1	8,37
ANELLO CON COPERTURA BIANCO / RING WITH WHITE COVER	70/30	GIADAT1W	8031453023706	1	7,95
ANELLO CON GRIGLIA BIANCO / RING WITH WHITE GRID	GRIGLIA / GRID	GIADAT2W	8031453023720	1	8,37

COCO
PLAFONIERA
CEILING LIGHT

BTL CATEGORIA SCONTO 23

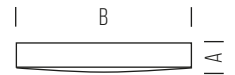

DIMENSIONI	A	B
1	85	250
2	85	300
3	85	350

DIMENSIONI CON ANELLO	A	B
1	85	261
2	85	311
3	85	361



IT

- Plafoniera in policarbonato per applicazioni a soffitto e parete
- Personalizzabile con anello di colore grigio già incluso nella confezione
- Flusso luminoso uniforme

EN

- Ceiling light with polycarbonate diffuser for mounting on ceiling or wall
- Customizable with grey ring already included in the kit
- Uniform light flow

IP44

220V
240V

25.000 H

INSTANT

-20° **+40°**

NOT DIMMABLE

POTENZA WATT	BASE	KELVIN	LUMEN LM	FASCIO °	MISURE MM	VARIANTE	CODICE	EAN	IMBALLO	€ IVA ESCLUSA
10	-	3000	700	120	1	-	COC0102	8031453015213	1/5	25,44
16	-	3000	1100	120	2	-	COC0162	8031453015237	1/5	32,33
16	-	4000	1200	120	2	-	COC0163	8031453015251	1/5	32,33
21	-	3000	1500	120	3	-	COC0212	8031453015275	1/5	40,28

RIO
PLAFONIERA
CEILING LIGHT

BTL CATEGORIA SCONTO 23

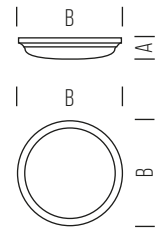

DIMENSIONI	A	B
1	80	305
2	88	400



IT

- Plafoniera in policarbonato versatile e di facile installazione (ad esempio per bagni, garage, corridoi, scale, etc.)
- Disponibile in due dimensioni

EN

- Versatile, easy-to-install ceiling light with polycarbonate diffuser (e.g. for bathrooms, garages, corridors, stairs, etc.)
- Available in two different sizes.

IP44

220V
240V

35.000 H

INSTANT

-30° +45°

NOT DIMMABLE

POTENZA WATT	BASE	KELVIN	LUMEN LM	FASCIO °	MISURE MM	VARIANTE	CODICE	EAN	IMBALLO	€ IVA ESCLUSA
12	-	3000	1000	150	1	-	4116137	6435200193445	1/6	56,18
12	-	4000	1000	150	1	-	4116170	6435200194237	1/6	56,18
20	-	3000	1600	150	2	-	4116164	6435200193452	1/6	81,62

RIO
PLAFONIERA RADAR
RADAR CEILING LIGHT

BTL CATEGORIA SCONTO 23

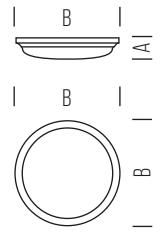

DIMENSIONI	A	B
1	80	305

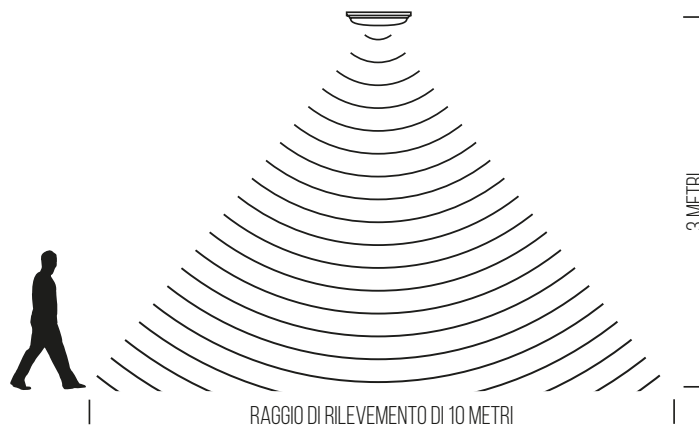

IT

- Plafoniera in policarbonato versatile e di facile installazione (ad esempio per bagni, garage, corridoi, scale, etc.)
- Versione con sensore di movimento a microonde regolabile:
 - Luce ambiente: 2-50 lux - disabilitato
 - Distanza di rilevamento: 2-10m
 - Tempo di accensione: 5sec - 30min
- Altezza di installazione: 2-3m

EN

- Versatile, easy-to-install ceiling light with polycarbonate diffuser (e.g. for bathrooms, garages, corridors, stairs, etc.)
- Version with adjustable microwave movement sensor:
 - Ambient light level: 2-50 lux - disabled
 - Movement detection range: 2-10m
 - Light-on time: 5sec - 30min
- Height of installation: 2-3m

IP44
220V/240V
35.000 H
INSTANT
-30° +45°
ON
RADAR
m

POTENZA WATT	BASE	KELVIN	LUMEN LM	FASCIO °	MISURE MM	VARIANTE	CODICE	EAN	IMBALLO	€ IVA ESCLUSA
12	-	3000	1000	150	1	-	4116165	6435200193469	1/6	79,50

SONO III PIR
PLAFONIERA PIR
PIR CEILING LIGHT

BTL CATEGORIA SCONTO 23

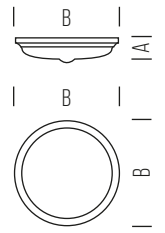

DIMENSIONI	A	B
1	89	296



IT

- Plafoniera in policarbonato particolarmente indicata per frequenti accensioni e spegnimenti
- Sensore di presenza PIR con sistema master/slave.
- Pilota fino ad altre due plafoniere SONO III PIR
- Regolazioni del sensore:
 - Tempo di accensione: 15s – 8min
 - Distanza di rilevamento: 2-8 m
 - Luminosità ambientale: 3-2000 lux
- Altezza di installazione: 2-3 m

EN

- Ceiling light with polycarbonate diffuser particularly recommended for frequent on/off
- PIR presence sensor with master/slave system.
- Drives up to two more SONO III PIR luminaires
- Sensor adjustments:
 - Light-on time: 15s – 8min
 - Detection distance: 2-8 m
 - Ambient light level: 3-2000 lux
- Installation height: 2-3 m

POTENZA WATT	BASE	KELVIN	LUMEN LM	FASCIO °	MISURE MM	VARIANTE	CODICE	EAN	IMBALLO	€ IVA ESCLUSA
15	-	3500	1300	120	1	-	4116463	6435200216410	1/5	78,44

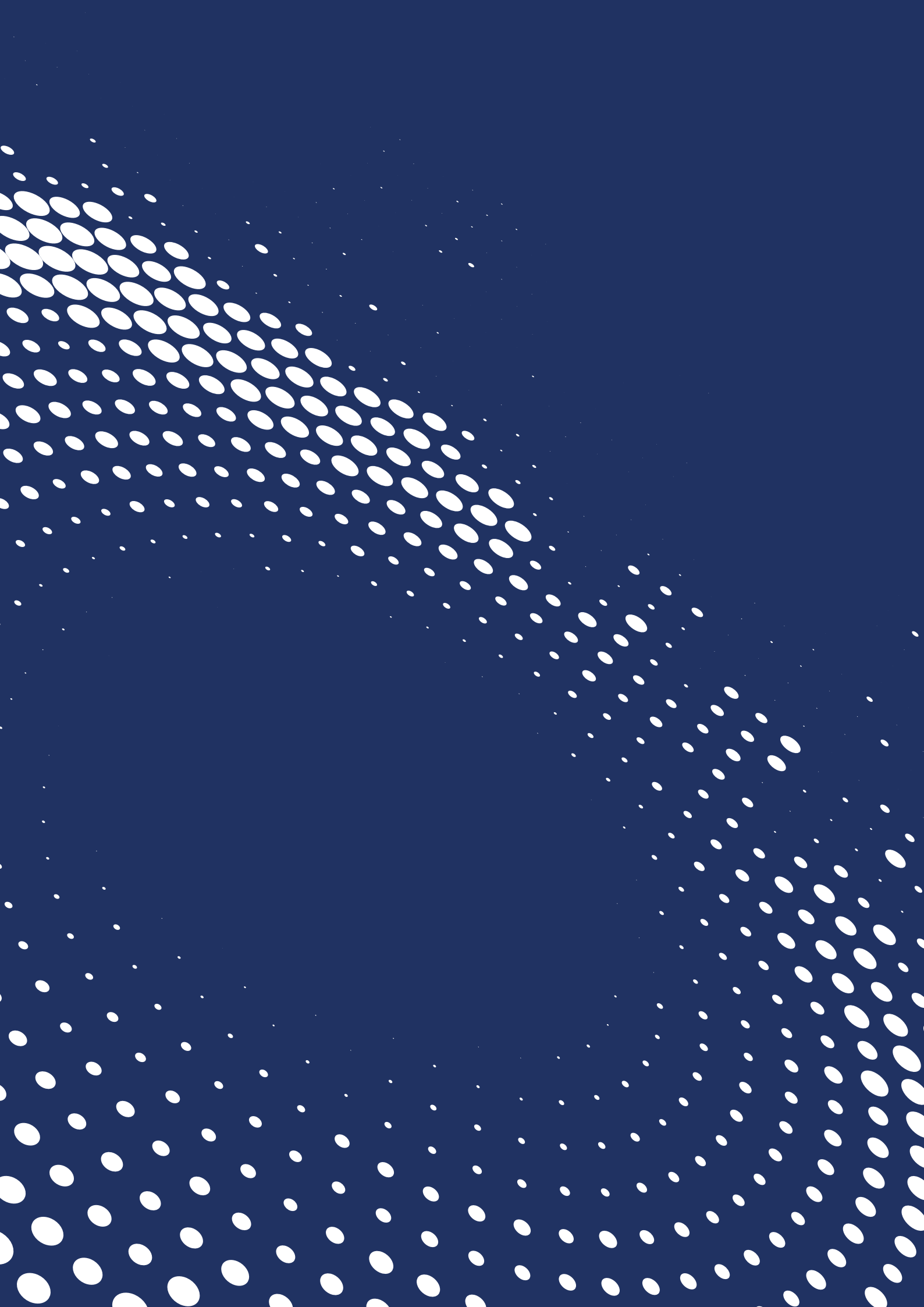

A decorative graphic in the bottom-left corner consisting of a series of white dots of varying sizes, arranged in a pattern that suggests a sunburst or a stylized floral motif.

OUTDOOR RESIDENZIALE RESIDENTIAL OUTDOOR

GIRONA
APPLIQUE
WALL LIGHT

BTL CATEGORIA SCONTO 24

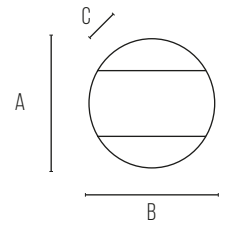

DIMENSIONI	A	B	C
1	120	120	115
2	160	160	155

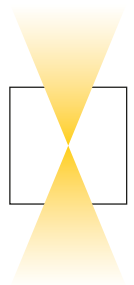
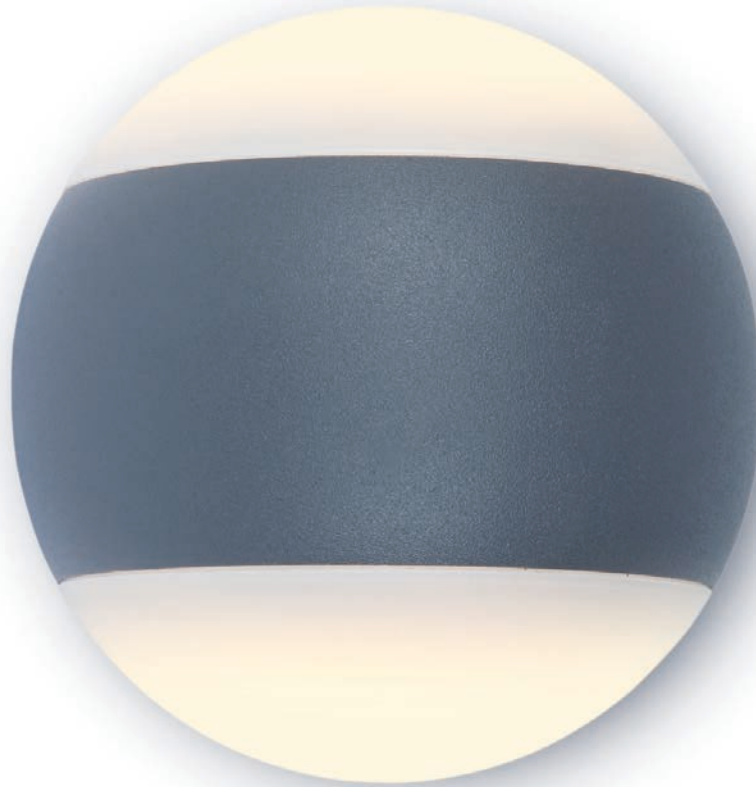

fascio doppio
double beam

IT

- Moduli LED integrati 2x5W o 2x10W (doppia emissione)
- Corpo in alluminio pressofuso verniciato grigio antracite
- Due dimensioni disponibili

EN

- Built-in LED modules 2x5W or 2x10W (up and down)
- Die-cast aluminium body with anthracite grey paint finish
- Two sizes available

IP65

100V
240V

15.000H

INSTANT

CLASS I

-20° +45°

NOT DIMMABLE

POTENZA WATT	BASE	KELVIN	LUMEN LM	FASCIO °	MISURE MM	VARIANTE	CODICE	EAN	IMBALLO	€ IVA ESCLUSA
10	-	4000	600	2X100	1	ANTRACITE / ANTHRACITE	GIRONA10	8031453021030	1/8	74,20
20	-	4000	1200	2X100	2	ANTRACITE / ANTHRACITE	GIRONA18	8031453021047	1/6	129,32

ALICANTE
APPLIQUE
WALL LIGHT

BTL CATEGORIA SCONTO 24

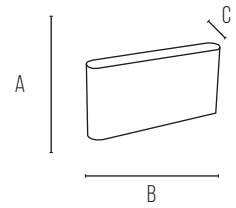

DIMENSIONI	A	B	C
1	90	175	30



CCT Selezionabile /
selectable CCT:
3000K, 4000K,
6000K

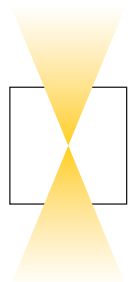

fascio doppio
double beam

IT

- Corpo in alluminio pressofuso verniciato
- Moduli LED integrati 2x6W (doppia emissione)
- Temperatura di colore impostabile mediante selettore

EN

- Die-cast aluminium body with paint finish
- Built-in LED 2x6W (up and down)
- Colour temperature can be set by selector

IP54

**220V
240V**

20.000H

INSTANT

CLASS I

-20° +45°

**NOT
DIMMABLE**

POTENZA WATT	BASE	KELVIN	LUMEN LM	FASCIO °	MISURE MM	VARIANTE	CODICE	EAN	IMBALLO	€ IVA ESCLUSA
12	-	3000 4000 6000	580	2X150	1	BIANCO / WHITE	ALICANTE 10B	8031453022013	1/20	49,82
12	-	3000 4000 6000	500	2X150	1	ANTRACITE / ANTHRACITE	ALICANTE 10G	8031453022020	1/20	49,82



NÄSBY II
APPLIQUE
WALL LIGHT

BTL CATEGORIA SCONTO 24

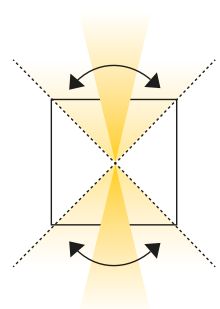
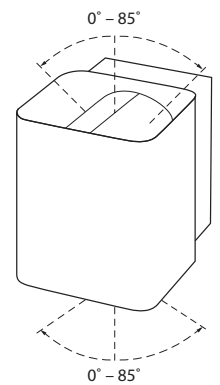
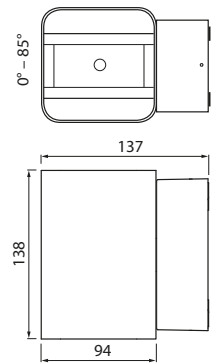

Up & down light
regolabile / adjustable



IT

- Applique da parete in alluminio per interni ed esterni
- Moduli LED integrati 2x6W (doppia emissione)
- Doppio fascio regolabile 0° - 80° senza l'uso di attrezzi

EN

- Interior and exterior wall light in aluminium
- Built-in LED modules 2x6W (up and down)
- Double light beam adjustable individually 0°-80° no tools needed

IP54

220V
240V

30.000 H

INSTANT

CLASS I

-20° **+35°**

NOT DIMMABLE

POTENZA WATT	BASE	KELVIN	LUMEN LM	FASCIO °	MISURE MM	VARIANTE	CODICE	EAN	IMBALLO	€ IVA ESCLUSA
12	-	3000	860	0-80	1	BIANCO / WHITE	4508600	6435200255082	1/8	143,10
12	-	3000	860	0-80	1	ANTRACITE / ANTHRACITE	4508601	6435200255105	1/8	143,10
12	-	4000	860	0-80	1	BIANCO / WHITE	4508602	6435200255129	1/8	143,10
12	-	4000	860	0-80	1	ANTRACITE / ANTHRACITE	4508603	6435200255143	1/8	143,10

MARBELLA SQUARED
APPLIQUE
WALL LIGHT

BTL CATEGORIA SCONTO 24

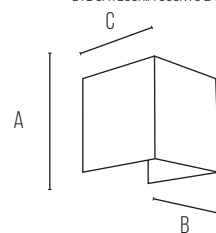

JNI	A	B	C
	100	100	100

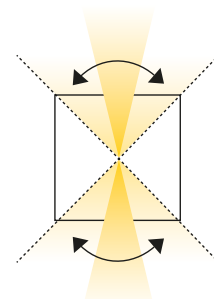
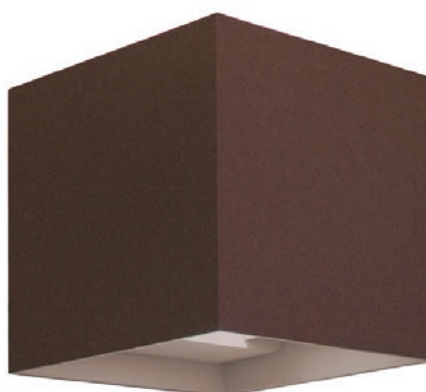
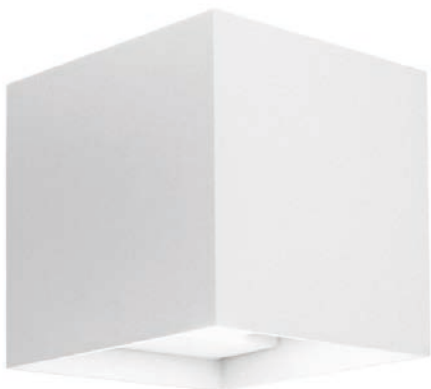

Up & down light
regolabile / adjustable

IT

- Applique da parete in alluminio per interni ed esterni
- Moduli LED integrati 2x5W (doppia emissione)
- Doppio fascio regolabile 0° - 90° senza l'uso di attrezzi

EN

- Interior and exterior wall light in aluminium
- Built-in LED modules 2x5W (up and down)
- Double light beam adjustable individually 0°-90° no tools needed

IP54

220V
240V

20.000H

INSTANT

CLASS I

-20° +45°

NOT DIMMABLE

POTENZA WATT	BASE	KELVIN	LUMEN LM	FASCIO °	MISURE MM	VARIANTE	CODICE	EAN	IMBALLO	€ IVA ESCLUSA
10	-	4000	610	2X90	1	BIANCO / WHITE	MARBELLA10BQ	8031453021962	1/20	42,29
10	-	4000	480	2X90	1	ANTRACITE / ANTHRACITE	MARBELLA10GQ	8031453021979	1/20	42,29
10	-	4000	520	2X90	1	GRIGIO MARINA / LIGHT GREY	MARBELLA10MQ	8031453021986	1/20	42,29
10	-	4000	480	2X90	1	CORTEN	MARBELLA10CQ	8031453023782	1/20	42,29

MARBELLA ROUND
APPLIQUE
WALL LIGHT

BTL CATEGORIA SCONTO 24

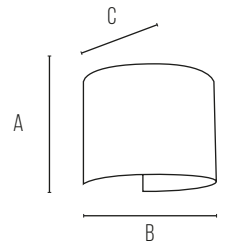

DIMENSIONI	A	B	C
1	100	135	115

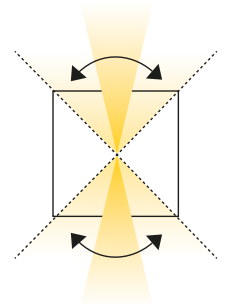

Up & down light
regolabile / adjustable

IT

- Applique da parete in alluminio per interni ed esterni
- Moduli LED integrati 2x5W (doppia emissione)
- Doppio fascio regolabile 0° - 90° senza l'uso di attrezzi

EN

- Interior and exterior wall light in aluminium
- Built-in LED modules 2x5W (up and down)
- Double light beam adjustable individually 0°-90° no tools needed

IP54

220V
240V

20.000 H

INSTANT

CLASS I

-20° +45°

NOT DIMMABLE

POTENZA WATT	BASE	KELVIN	LUMEN LM	FASCIO °	MISURE MM	VARIANTE	CODICE	EAN	IMBALLO	€ IVA ESCLUSA
10	-	4000	610	2X90	1	BIANCO / WHITE	MARBELLA10BR	8031453021931	1/20	42,29
10	-	4000	480	2X90	1	ANTRACITE / ANTHRACITE	MARBELLA10GR	8031453021948	1/20	42,29
10	-	4000	520	2X90	1	GRIGIO MARINA / LIGHT GREY	MARBELLA10MR	8031453021955	1/20	42,29
10	-	4000	480	2X90	1	CORTEN	MARBELLA10CR	8031453023799	1/20	42,29

TOLEDO

APPLIQUE SINGOLA EMISSIONE
MONO EMISSION WALL LAMP

BTL CATEGORIA SCONTO 24

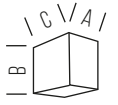

DIMENSIONI	A	B	C
1	68	100	78

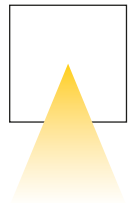

fascio singolo
single beam

IT

- Applique da parete in alluminio con schermo in vetro per interni ed esterni
- Attacco GU10 per sorgenti LED max 35W

EN

- Interior and exterior wall light in aluminium with glass diffuser
- GU10 base for LED light sources max 35W

IP54

-20° ❄️ **+45°**

POTENZA WATT	BASE	KELVIN	LUMEN LM	FASCIO °	MISURE MM	VARIANTE	CODICE	EAN	IMBALLO	€ IVA ESCLUSA
-	GU10	-	-	-	1	BIANCO / WHITE	TOLEDO1B	8031453023829	1/8	16,85
-	GU10	-	-	-	1	ANTRACITE / ANTHRACITE	TOLEDO1G	8031453023843	1/8	16,85
-	GU10	-	-	-	1	GRIGIO MARINA / LIGHT GREY	TOLEDO1M	8031453023850	1/8	16,85
-	GU10	-	-	-	1	CORTEN	TOLEDO1C	8031453023836	1/8	16,85

TOLEDO

APPLIQUE DOPPIA EMISSIONE
DOUBLE EMISSION WALL LAMP

BTL CATEGORIA SCONTO 24



DIMENSIONI	A	B	C
1	68	160	78

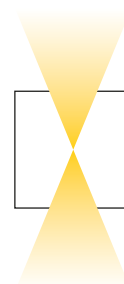

fascio doppio
double beam

IT

- Applique da parete in alluminio con schermo in vetro per interni ed esterni
- Attacco GU10 per sorgenti LED 2 x max 35W

EN

- Interior and exterior wall light in aluminium with glass diffuser
- GU10 base for LED light sources 2 x max 35W



POTENZA WATT	BASE	KELVIN	LUMEN LM	FASCIO °	MISURE MM	VARIANTE	CODICE	EAN	IMBALLO	€ IVA ESCLUSA
-	GU10	-	-	-	1	BIANCO / WHITE	TOLED02B	8031453023867	1/8	23,21
-	GU10	-	-	-	1	ANTRACITE / ANTHRACITE	TOLED02G	8031453023881	1/8	23,21
-	GU10	-	-	-	1	GRIGIO MARINA / LIGHT GREY	TOLED02M	8031453023898	1/8	23,21
-	GU10	-	-	-	1	CORTEN	TOLED02C	8031453023874	1/8	23,21

SUND

APPLIQUE SINGOLA EMISSIONE
MONO EMISSION WALL LAMP

BTL CATEGORIA SCONTO 24



DIMENSIONI	A	B	C
1	68	80	93



fascio singolo
single beam

IT

- Applique da parete in alluminio con schermo in vetro per interni ed esterni
- Attacco GU10 per sorgenti LED max 11W

EN

- Interior and exterior wall light in aluminium with glass diffuser
- GU10 base for LED light sources max 11W



POTENZA WATT	BASE	KELVIN	LUMEN LM	FASCIO °	MISURE MM	VARIANTE	CODICE	EAN	IMBALLO	€ IVA ESCLUSA
-	GU10	-	-	-	1	BIANCO / WHITE	4118740	6435200226129	1/8	33,39
-	GU10	-	-	-	1	ANTRACITE / ANTHRACITE	4118745	6435200226228	1/8	33,39

SUND

APPLIQUE DOPPIA EMISSIONE
DOUBLE EMISSION WALL LAMP

BTL CATEGORIA SCONTO 24

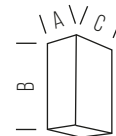

DIMENSIONI	A	B	C
1	68	150	93

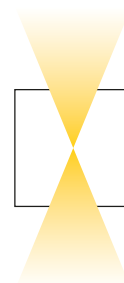

fascio doppio
double beam

IT

- Applique da parete in alluminio con schermo in vetro per interni ed esterni
- Attacco GU10 per sorgenti LED max 2x11W

EN

- Interior and exterior wall light in aluminium with glass diffuser
- GU10 base for LED light sources max 2x11W



POTENZA WATT	BASE	KELVIN	LUMEN LM	FASCIO °	MISURE MM	VARIANTE	CODICE	EAN	IMBALLO	€ IVA ESCLUSA
-	GU10	-	-	-	1	BIANCO / WHITE	4118742	6435200226167	1/8	45,05
-	GU10	-	-	-	1	ANTRACITE / ANTHRACITE	4118746	6435200226242	1/8	45,05

CORDOVA

APPLIQUE SINGOLA EMISSIONE
MONO EMISSION WALL LAMP

BTL CATEGORIA SCONTO 24

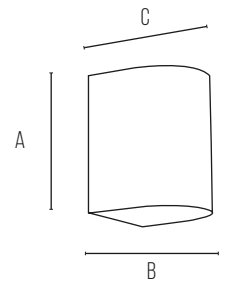

DIMENSIONI	A	B	C
1	100	68	78

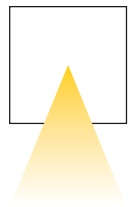

fascio singolo
single beam

IT

- Applique da parete in alluminio con schermo in vetro per interni ed esterni
- Attacco GU10 per sorgenti LED max 35W

EN

- Interior and exterior wall light in aluminium with glass diffuser
- GU10 base for LED light sources max 35W



POTENZA WATT	BASE	KELVIN	LUMEN LM	FASCIO °	MISURE MM	VARIANTE	CODICE	EAN	IMBALLO	€ IVA ESCLUSA
-	GU10	-	-	-	1	BIANCO / WHITE	CORDOVA1B	8031453021849	1/40	14,95
-	GU10	-	-	-	1	ANTRACITE / ANTHRACITE	CORDOVA1G	8031453021856	1/40	14,95
-	GU10	-	-	-	1	GRIGIO MARINA / LIGHT GREY	CORDOVA1M	8031453021863	1/40	14,95
-	GU10	-	-	-	1	CORTEN	CORDOVA1C	8031453023805	1/40	14,95

CORDOVA

APPLIQUE DOPPIA EMISSIONE
DOUBLE EMISSION WALL LAMP

BTL CATEGORIA SCONTO 24

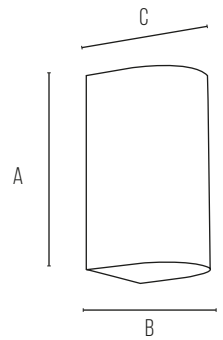

DIMENSIONI	A	B	C
1	160	68	78

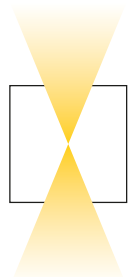

fascio doppio
double beam

IT

- Applique da parete in alluminio con schermo in vetro per interni ed esterni
- Attacco GU10 per sorgenti LED max 2x35W

EN

- Interior and exterior wall light in aluminium with glass diffuser
- GU10 base for LED light sources max 2x35W



POTENZA WATT	BASE	KELVIN	LUMEN LM	FASCIO °	MISURE MM	VARIANTE	CODICE	EAN	IMBALLO	€ IVA ESCLUSA
-	GU10	-	-	-	1	BIANCO / WHITE	CORDOVA2B	8031453021870	1/20	20,67
-	GU10	-	-	-	1	ANTRACITE / ANTHRACITE	CORDOVA2G	8031453021887	1/20	20,67
-	GU10	-	-	-	1	GRIGIO MARINA / LIGHT GREY	CORDOVA2M	8031453021894	1/20	20,67
-	GU10	-	-	-	1	CORTEN	CORDOVA2C	8031453023812	1/20	20,67

ALPPILA 1S

 APPLIQUE SINGOLA EMISSIONE
 MONO EMISSION WALL LAMP

BTL CATEGORIA SCONTO 24

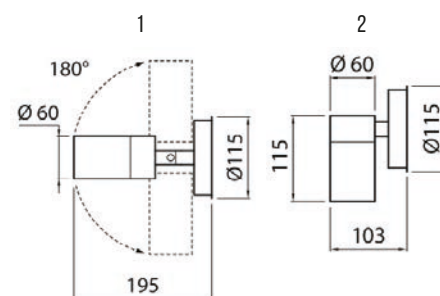
 fascio singolo
 single beam

IT

- Applique da parete in acciaio inox con schermo in vetro temperato per interni ed esterni
- Attacco GU10 per sorgenti LED ed alogene max 35W
- Versione fissa ed orientabile

EN

- Interior and exterior wall light in stainless steel with tempered glass diffuser
- GU10 base for halogen and LED light sources max 35W
- Fixed and adjustable version

IP44

POTENZA WATT	BASE	KELVIN	LUMEN LM	FASCIO °	MISURE MM	VARIANTE	CODICE	EAN	IMBALLO	€ IVA ESCLUSA
-	GU10	-	-	-	1	ORIENTABILE / ADJUSTABLE	4107268	6435200147547	1/12	40,28
-	GU10	-	-	-	2	FISSA / FIXED	4107269	6435200147561	1/12	37,10

ALPPILA 2S

APPLIQUE DOPPIA EMISSIONE
DOUBLE EMISSION WALL LAMP

BTL CATEGORIA SCONTO 24

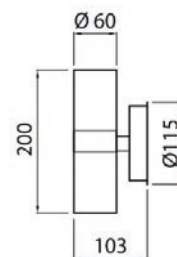

fascio doppio
double beam

IT

- Applique da parete in acciaio inox con schermo in vetro temperato per interni ed esterni
- Attacco GU10 per sorgenti LED ed alogene max 2x35W

EN

- Interior and exterior wall light in stainless steel with tempered glass diffuser
- GU10 base for halogen and LED light sources max 2x35W



POTENZA WATT	BASE	KELVIN	LUMEN LM	FASCIO °	MISURE MM	VARIANTE	CODICE	EAN	IMBALLO	€ IVA ESCLUSA
-	GU10	-	-	-	1	ANTRACITE / ANTHRACITE	4116166	6435200193490	1/12	43,46
-	GU10	-	-	-	1	BIANCO / WHITE	4116167	6435200193506	1/12	43,46
-	GU10	-	-	-	1	ACCIAIO / STEEL	4107271	6435200147585	1/12	41,34

ALPPILA XL
APPLIQUE DOPPIA EMISSIONE
DOUBLE EMISSION WALL LAMP

BTL CATEGORIA SCONTO 24

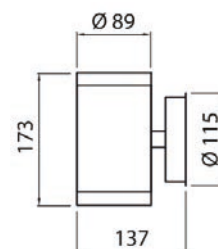

fascio doppio
double beam

IT

- Applique da parete in acciaio inox con schermo in vetro temperato per interni ed esterni
- Attacco GU10 per sorgenti LED ed alogene max 2x35W

EN

- Interior and exterior wall light in stainless steel with tempered glass diffuser
- GU10 base for halogen and LED light sources max 2x35W



POTENZA WATT	BASE	KELVIN	LUMEN LM	FASCIO °	MISURE MM	VARIANTE	CODICE	EAN	IMBALLO	€ IVA ESCLUSA
-	GU10	-	-	-	1	BIANCO / WHITE	4508465	6435200196163	1/12	58,30
-	GU10	-	-	-	1	ANTRACITE / ANTHRACITE	4508466	6435200196187	1/12	58,30

GRANADA

APPLIQUE DOPPIA EMISSIONE
DOUBLE EMISSION WALL LAMP

BTL CATEGORIA SCONTO 24

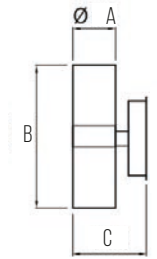

DIMENSIONI	A	B	C
1	60	163	95

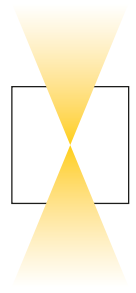

fascio doppio
double beam

IT

- Applique da parete in alluminio con schermo in vetro per interni ed esterni
- Attacco GU10 per sorgenti LED ed alogene max 2x35W

EN

- Interior and exterior wall light in aluminium with glass diffuser
- GU10 base for halogen and LED light sources max 2x35W



POTENZA WATT	BASE	KELVIN	LUMEN LM	FASCIO °	MISURE MM	VARIANTE	CODICE	EAN	IMBALLO	€ IVA ESCLUSA
-	GU10	-	-	-	1	BIANCO / WHITE	GRANADA2B	8031453021900	1/20	23,74
-	GU10	-	-	-	1	ANTRACITE / ANTHRACITE	GRANADA2G	8031453021917	1/20	23,74
-	GU10	-	-	-	1	GRIGIO MARINA / LIGHT GREY	GRANADA2M	8031453021924	1/20	23,74

ARVIKA
 APPLIQUE
 WALL LAMP

BTL CATEGORIA SCONTO 24

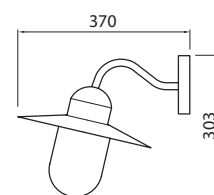
IT

- Apparecchio da parete tradizionale per l'illuminazione del giardino, terrazze etc...
- Coperchio trasparente con vetro a bolla
- Monta una sorgente led con attacco E27 – 60W max. (non inclusa)

IP44
EN

- Traditional wall luminaire for the garden, terraces etc.
- Transparent glass dome diffuser
- Requires a LED light source with E27 base – 60W max. (not included)

POTENZA WATT	BASE	KELVIN	LUMEN LM	FASCIO °	MISURE MM	VARIANTE	CODICE	EAN	IMBALLO	€ IVA ESCLUSA
-	E27	-	-	-	1	BIANCO / WHITE	4107297	6435200157874	1/6	41,34
-	E27	-	-	-	1	NERO / BLACK	4107298	6435200157898	1/6	41,34

AURA
APPLIQUE
WALL LAMP

BTL CATEGORIA SCONTO 24

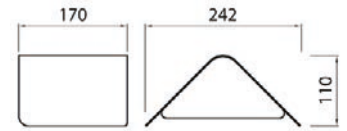

IT

- Applique da parete per interni ed esterni
- Modulo LED integrato
- Corpo in alluminio/acciaio

EN

- Interior and exterior wall light
- Built-in LED module
- Aluminium/steel body

IP54

**220v
240v**

25.000H

INSTANT

CLASS I

-20° +40°

NOT DIMMABLE

POTENZA WATT	BASE	KELVIN	LUMEN LM	FASCIO °	MISURE MM	VARIANTE	CODICE	EAN	IMBALLO	€ IVA ESCLUSA
12	-	3000	880	-	1	ANTRACITE / ANTHRACITE	4118739	6435200226105	1/6	127,20

ALTA
PLAFONIERA
CEILING LAMP

BTL CATEGORIA SCONTO 24

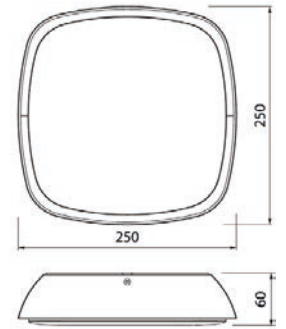

IT

- Apparecchio a plafone per esterni
- Corpo in alluminio pressofuso di colore grigio antracite con protezione UV
- Fronte in policarbonato

EN

- Outdoor ceiling light
- Body in anthracite grey die-cast aluminium with UV protection
- Diffuser in polycarbonate

IP44

**220V
240V**

30.000 H

INSTANT

CLASS I

-20° +35°

NOT DIMMABLE

POTENZA WATT	BASE	KELVIN	LUMEN LM	FASCIO °	MISURE MM	VARIANTE	CODICE	EAN	IMBALLO	€ IVA ESCLUSA
20	-	3000	1800	110	1	ANTRACITE / ANTHRACITE	4126254	6435200240972	1/4	90,10

MAIORCA
APPLIQUE
WALL LAMP

AGGIORNATO

BTL CATEGORIA SCONTO 24

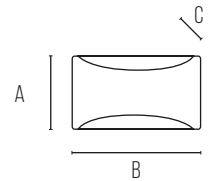

DIMENSIONI	A	B	C
1	90	220	77

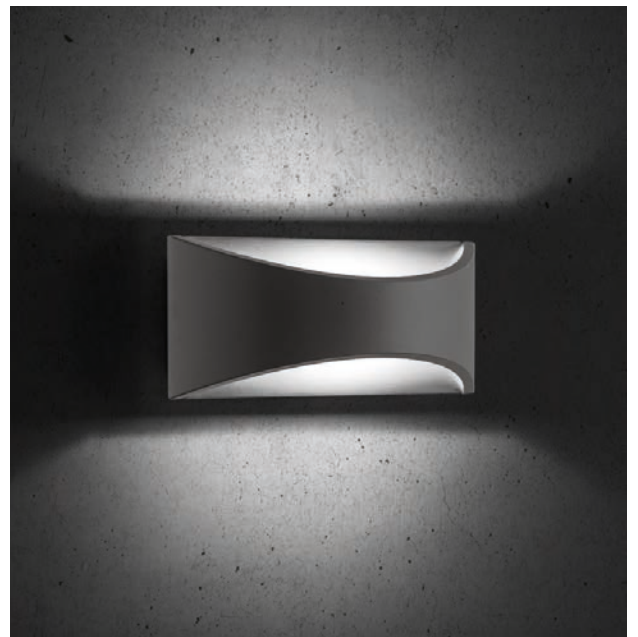

IT

- Applique da parete in alluminio per interni ed esterni
- Modulo LED integrato 6W (illuminazione indiretta)

EN

- Interior and exterior wall light in aluminium
- Built-in LED module 6W (indirect lighting)



POTENZA WATT	BASE	KELVIN	LUMEN LM	FASCIO °	MISURE MM	VARIANTE	CODICE	EAN	IMBALLO	€ IVA ESCLUSA
6	-	4000	430	120	1	BIANCO / WHITE	MAIORCA6B	8031453021993	1/20	47,70
6	-	4000	280	120	1	GRIGIO MARINA / LIGHT GREY	MAIORCA6M	8031453022006	1/20	47,70

SEGOVIA 1
APPLIQUE
WALL LAMP

BTL CATEGORIA SCONTO 24

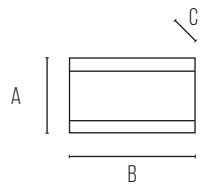

DIMENSIONI	A	B	C
1	108	220	121



*solo per versione E27 / only for E27 version

IT

- Applique da parete con corpo in alluminio e diffusore in policarbonato
- Disponibile con modulo led FLICKER-FREE SOSTITUIBILE o attacco E27
- Modulo 3000K opzionale

EN

- Wall light with aluminium body and polycarbonate diffuser
- Available with REPLACEABLE FLICKER-FREE LED module or E27 base
- Optional 3000K module



POTENZA WATT	BASE	KELVIN	LUMEN LM	FASCIO °	MISURE MM	VARIANTE	CODICE	EAN	IMBALLO	€ IVA ESCLUSA
10	-	4000	720	180	1	BIANCO / WHITE	SEGOVIA110B	8031453021122	1/12	29,15
10	-	4000	540	180	1	CORTEN	SEGOVIA110C	8031453020781	1/12	29,15
10	-	4000	560	180	1	ANTRACITE / ANTHRACITE	SEGOVIA110G	8031453020774	1/12	29,15
-	E27	-	-	-	1	BIANCO / WHITE	SEGOVIA1E27B	8031453020835	1/12	24,91
-	E27	-	-	-	1	CORTEN	SEGOVIA1E27C	8031453020842	1/12	24,91
-	E27	-	-	-	1	ANTRACITE / ANTHRACITE	SEGOVIA1E27G	8031453021153	1/12	24,91
-	E27	-	-	-	1	GRIGIO MARINA / LIGHT GREY*	SEGOVIA1E27M	8031453023751	1/12	24,91

SEGOVIA 2
APPLIQUE
WALL LAMP

BTL CATEGORIA SCONTO 24

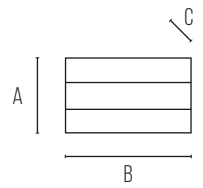

DIMENSIONI	A	B	C
1	108	220	121



*solo per versione E27 / only for E27 version

IT

- Applique da parete con corpo in alluminio e diffusore in policarbonato
- Disponibile con modulo led FLICKER-FREE SOSTITUIBILE o attacco E27
- Modulo 3000K opzionale

EN

- Wall light with aluminium body and polycarbonate diffuser
- Available with REPLACEABLE FLICKER-FREE LED module or E27 base
- Optional 3000K module



POTENZA WATT	BASE	KELVIN	LUMEN LM	FASCIO °	MISURE MM	VARIANTE	CODICE	EAN	IMBALLO	€ IVA ESCLUSA
10	-	4000	590	180	1	BIANCO / WHITE	SEGOVIA210B	8031453020798	1/12	29,15
10	-	4000	390	180	1	CORTEN	SEGOVIA210C	8031453020804	1/12	29,15
10	-	4000	400	180	1	ANTRACITE / ANTHRACITE	SEGOVIA210G	8031453021139	1/12	29,15
-	E27	-	-	-	1	BIANCO / WHITE	SEGOVIA2E27B	8031453020866	1/12	24,91
-	E27	-	-	-	1	CORTEN	SEGOVIA2E27C	8031453020873	1/12	24,91
-	E27	-	-	-	1	ANTRACITE / ANTHRACITE	SEGOVIA2E27G	8031453020859	1/12	24,91
-	E27	-	-	-	1	GRIGIO MARINA / LIGHT GREY*	SEGOVIA2E27M	8031453023768	1/12	24,91

SEGOVIA 3
APPLIQUE
WALL LAMP

BTL CATEGORIA SCONTO 24

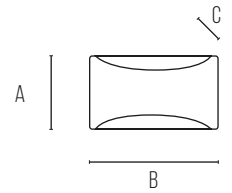

DIMENSIONI	A	B	C
1	100	220	99



*solo per versione E27 / only for E27 version

IT

- Applique da parete con corpo in alluminio e diffusore in policarbonato
- Disponibile con modulo led FLICKER-FREE SOSTITUIBILE o attacco E27
- Modulo 3000K opzionale

EN

- Wall light with aluminium body and polycarbonate diffuser
- Available with REPLACEABLE FLICKER-FREE LED module or E27 base
- Optional 3000K module



POTENZA WATT	BASE	KELVIN	LUMEN LM	FASCIO °	MISURE MM	VARIANTE	CODICE	EAN	IMBALLO	€ IVA ESCLUSA
10	-	4000	575	180	1	BIANCO / WHITE	SEGOVIA310B	8031453020811	1/12	28,09
10	-	4000	400	180	1	CORTEN	SEGOVIA310C	8031453020828	1/12	28,09
10	-	4000	390	180	1	ANTRACITE / ANTHRACITE	SEGOVIA310G	8031453021146	1/12	28,09
-	E27	-	-	-	1	BIANCO / WHITE	SEGOVIA3E27B	8031453020897	1/12	22,79
-	E27	-	-	-	1	CORTEN	SEGOVIA3E27C	8031453020903	1/12	22,79
-	E27	-	-	-	1	ANTRACITE / ANTHRACITE	SEGOVIA3E27G	8031453020880	1/12	22,79
-	E27	-	-	-	1	GRIGIO MARINA / LIGHT GREY*	SEGOVIA3E27M	8031453023775	1/12	22,79

SEGOVIA
ACCESSORI
ACCESSORIES

BTL CATEGORIA SCONTO 24

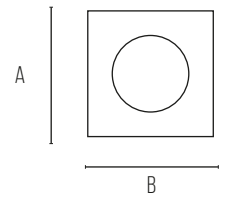

DIMENSIONI	A	B
1	50	50



IT

- Modulo LED FLICKER-FREE per SEGOVIA 1-2-3
- Disponibile in versione 3000K e 4000K
- Installazione veloce, fissaggio con viti, piastra dissipante e lente in dotazione

EN

- FLICKER-FREE LED module for SEGOVIA 1-2-3
- Available in versions 3000K and 4000K
- Quick installation, screw fastening, heat sink and lens supplied



POTENZA WATT	BASE	KELVIN	LUMEN LM	FASCIO °	MISURE MM	VARIANTE	CODICE	EAN	IMBALLO	€ IVA ESCLUSA
10	-	3000	1000	180	1	-	SEGOVIAMOD2	8031453020910	1/100	5,94
10	-	4000	1000	180	1	-	SEGOVIAMOD3	8031453020927	1/100	5,94

LEON
LANTERNA
LANTERN LAMP

BTL CATEGORIA SCONTO 24

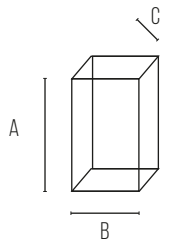

DIMENSIONI	A	B	C
1	280	150	100



IT

- Lanterna da parete con corpo in alluminio e schermi in vetro
- Attacco E27 (60W max)

EN

- Wall lantern made from aluminium with glass shades
- E27 base (60W max)



POTENZA WATT	BASE	KELVIN	LUMEN LM	FASCIO °	MISURE MM	VARIANTE	CODICE	EAN	IMBALLO	€ IVA ESCLUSA
-	E27	-	-	-	1	ANTRACITE / ANTHRACITE	LEON	8031453021054	1/6	54,06

SIVIGLIA
APPLIQUE
WALL LAMP

BTL CATEGORIA SCONTO 24

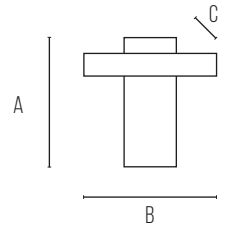

DIMENSIONI	A	B	C
1	115	210	148

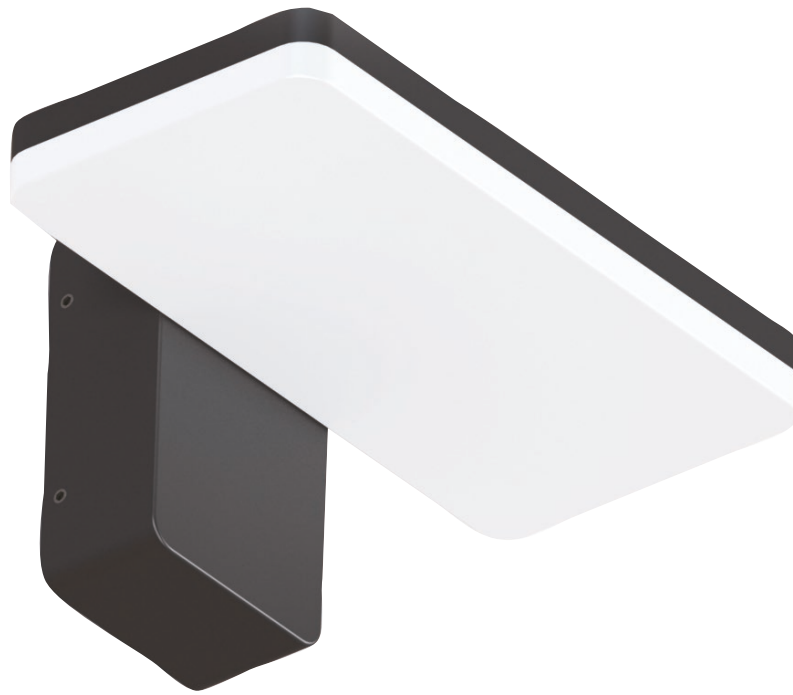

IT

- Applique da parete in alluminio verniciato
- Modulo LED integrato 12W

EN

- Wall light in painted aluminium
- Built-in LED module 12W



POTENZA WATT	BASE	KELVIN	LUMEN LM	FASCIO °	MISURE MM	VARIANTE	CODICE	EAN	IMBALLO	€ IVA ESCLUSA
12	-	4000	750	100	1	ANTRACITE / ANTHRACITE	SIVIGLIA 12P	8031453021078	1/8	87,98

SIVIGLIA

PALETTO DA GIARDINO
OUTDOOR BOLLARD

BTL CATEGORIA SCONTO 24

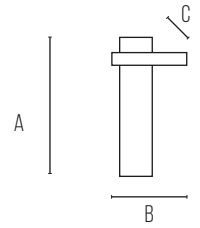

DIMENSIONI	A	B	C
1	800	145	210
2	800	215	210

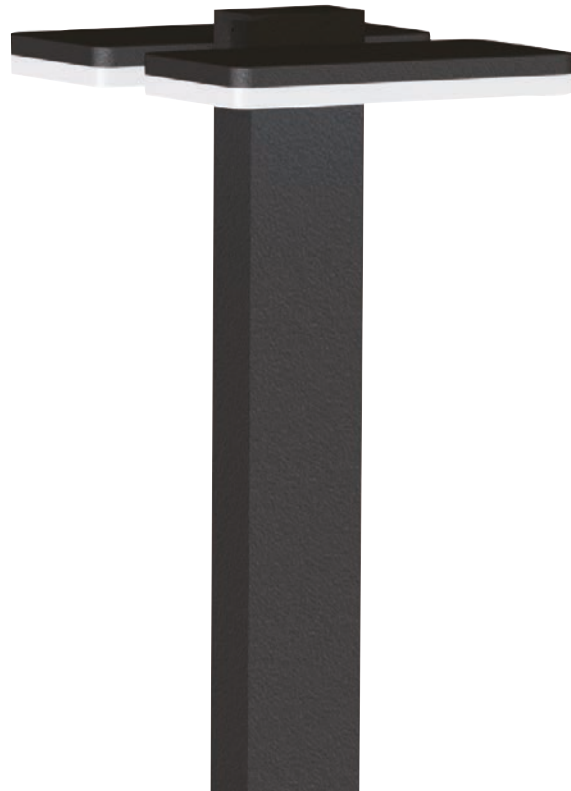

IT

- Bollard in alluminio verniciato
- Modulo LED integrato 1x12W o 2x12W

EN

- Bollard in painted aluminium
- Built-in LED module 1x12W or 2x12W



15.000 H



POTENZA WATT	BASE	KELVIN	LUMEN LM	FASCIO °	MISURE MM	VARIANTE	CODICE	EAN	IMBALLO	€ IVA ESCLUSA
12	-	4000	750	100	1	ANTRACITE / ANTHRACITE	SIVIGLIA12	8031453021085	1/4	129,32
24	-	4000	1500	2X100	2	ANTRACITE / ANTHRACITE	SIVIGLIA24	8031453021092	1/4	190,80

KALLIO

PALETTO DA GIARDINO
OUTDOOR BOLLARD

BTL CATEGORIA SCONTO 24

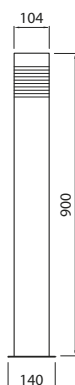

IT

- Corpo in acciaio inossidabile con diffusore in vetro
- Versione verniciato a polvere con finitura opaca
- Versione con rivestimento in pietra
- Attacco E27 (60W max, diametro massimo 45mm)

EN

- Made from stainless steel with glass diffuser
- Version with matt powder-coated paint finish
- Version with stone cladding
- E27 base (60W max, maximum diameter 45mm)



POTENZA WATT	BASE	KELVIN	LUMEN LM	FASCIO °	MISURE MM	VARIANTE	CODICE	EAN	IMBALLO	€ IVA ESCLUSA
-	E27	-	-	-	1	ANTRACITE / ANTHRACITE	4116122	6435200188960	1/2	103,88
-	E27	-	-	-	1	GRIGIO CHIARO / LIGHT GREY	4107274	6435200147646	1/2	103,88

PUUTARHAKOHDEVALO
PICCHETTO DA GIARDINO
OUTDOOR STAKE LIGHT

BTL CATEGORIA SCONTO 24

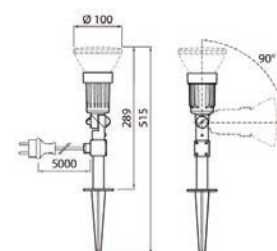

IT

- Picchetto decorativo per giardini o sentieri
- Inclinazione impostabile fino a 90°
- Perfetto in combinazione con PAR38LED
- Cavo lunghezza 5 metri con spina Schuko
- Attacco E27 (100W max)

EN

- Decorative stake light for gardens or paths
- Head adjustable up to 90°
- Great in combination with PAR38LED
- Supplied with 5-metre cable and Schuko plug
- E27 base (100W max)

IP44 CLASS I

POTENZA WATT	BASE	KELVIN	LUMEN LM	FASCIO °	MISURE MM	VARIANTE	CODICE	EAN	IMBALLO	€ IVA ESCLUSA
-	E27	-	-	-	1	NERO / BLACK	4107075	6435200010889	1/18	34,45

KURU

PICCHETTO DA GIARDINO
OUTDOOR STAKE LIGHT

BTL CATEGORIA SCONTO 24

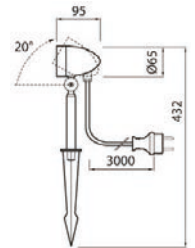

IT

- Picchetto decorativo per giardini o sentieri
- Orientabile
- Cavo lunghezza 3 metri con spina Schuko
- Attacco GU10 (11W max)

EN

- Decorative stake light for gardens or paths
- Adjustable
- Supplied with 3-metre cable and Schuko plug
- GU10 base (11W max)

IP54 CLASS I

POTENZA WATT	BASE	KELVIN	LUMEN LM	FASCIO °	MISURE MM	VARIANTE	CODICE	EAN	IMBALLO	€ IVA ESCLUSA
-	GU10	-	-	-	1	ANTRACITE / ANTHRACITE	4118747	6435200226266	1/6	58,30

BILBAO SQUARED
SEGNAPASSO
STEP LIGHT

AGGIORNATO

BTL CATEGORIA SCONTO 24

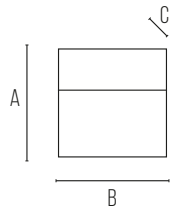

DIMENSIONI	A	B	C
1	105	105	23



IT

- Segnapasso quadrato in alluminio per applicazione a parete
- Modulo LED integrato da 3,5W

EN

- Squared aluminium steplight for wall mounting
- Built-in 3,5W LED module



15.000 H



POTENZA WATT	BASE	KELVIN	LUMEN LM	FASCIO °	MISURE MM	VARIANTE	CODICE	EAN	IMBALLO	€ IVA ESCLUSA
3,5	-	4000	160	64	1	BIANCO / WHITE	BILBA03BQ	8031453022655	1/20	24,06
3,5	-	4000	90	64	1	ANTRACITE / ANTHRACITE	BILBA03GQ	8031453022662	1/20	24,06
3,5	-	4000	120	64	1	GRIGIO MARINA / LIGHT GREY	BILBA03MQ	8031453022679	1/20	24,06

BILBAO SQUARED
SEGNAPASSO
STEP LIGHT

AGGIORNATO

BTL CATEGORIA SCONTO 24

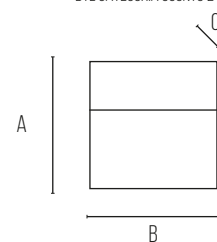

DIMENSIONI	A	B	C
1	159	159	28



IT

- Segnapasso quadrato in alluminio per applicazione a parete
- Modulo LED integrato da 6W

EN

- Squared aluminium steplight for wall mounting
- Built-in 6W LED module



POTENZA WATT	BASE	KELVIN	LUMEN LM	FASCIO °	MISURE MM	VARIANTE	CODICE	EAN	IMBALLO	€ IVA ESCLUSA
6	-	4000	300	72	1	CORTEN	BILBA06CQ	8031453022716	1/20	33,18
6	-	4000	290	72	1	ANTRACITE / ANTHRACITE	BILBA06GQ	8031453022723	1/20	33,18
6	-	4000	350	72	1	GRIGIO MARINA / LIGHT GREY	BILBA06MQ	8031453022730	1/20	33,18

BILBAO ROUND
SEGNAPASSO
STEP LIGHT

AGGIORNATO

BTL CATEGORIA SCONTO 24

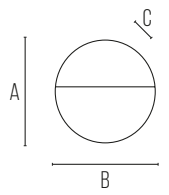

DIMENSIONI	A	B	C
1	110	110	25

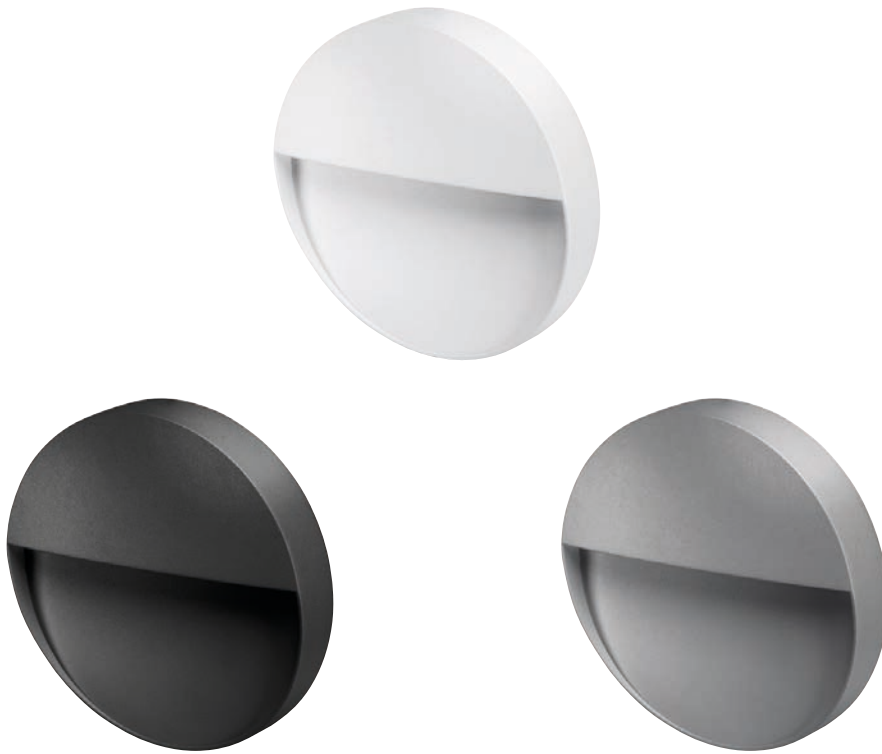

IT

- Segnapasso circolare in alluminio per applicazione a parete
- Modulo LED integrato da 3,5W

EN

- Round aluminium steplight for wall mounting
- Built-in 3,5W LED module



15.000 H

INSTANT

CLASS I

-20° +45°



POTENZA WATT	BASE	KELVIN	LUMEN LM	FASCIO °	MISURE MM	VARIANTE	CODICE	EAN	IMBALLO	€ IVA ESCLUSA
3,5	-	4000	160	64	1	BIANCO / WHITE	BILBA03BR	8031453022686	1/20	24,06
3,5	-	4000	90	64	1	ANTRACITE / ANTHRACITE	BILBA03GR	8031453022693	1/20	24,06
3,5	-	4000	120	64	1	GRIGIO MARINA / LIGHT GREY	BILBA03MR	8031453022709	1/20	24,06

BILBAO ROUND
SEGNAPASSO
STEP LIGHT

AGGIORNATO

BTL CATEGORIA SCONTO 24

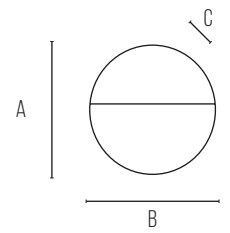

DIMENSIONI	A	B	C
1	159	159	32

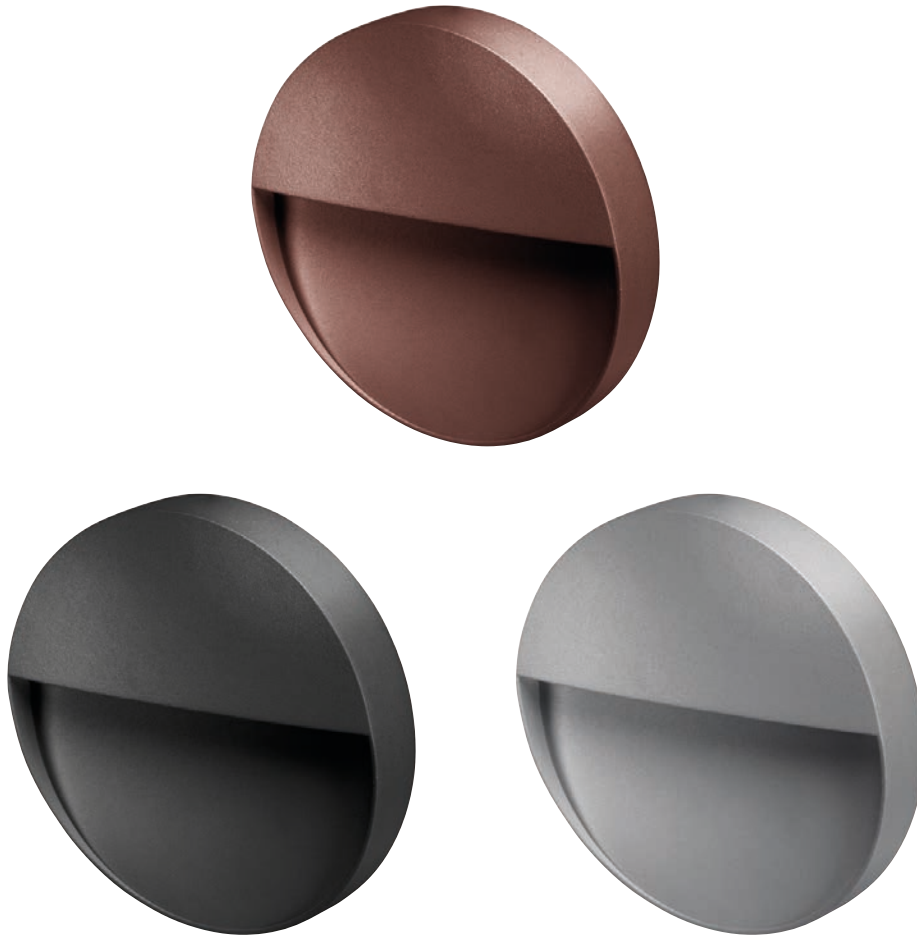

IT

- Segnapasso circolare in alluminio per applicazione a parete
- Modulo LED integrato da 6W

EN

- Round aluminium steplight for wall mounting
- Built-in 6W LED module



POTENZA WATT	BASE	KELVIN	LUMEN LM	FASCIO °	MISURE MM	VARIANTE	CODICE	EAN	IMBALLO	€ IVA ESCLUSA
6	-	4000	310	64	1	CORTEN	BILBAO6CR	8031453022747	1/20	33,18
6	-	4000	300	64	1	ANTRACITE / ANTHRACITE	BILBAO6GR	8031453022754	1/20	33,18
6	-	4000	360	64	1	GRIGIO MARINA / LIGHT GREY	BILBAO6MR	8031453022761	1/20	33,18

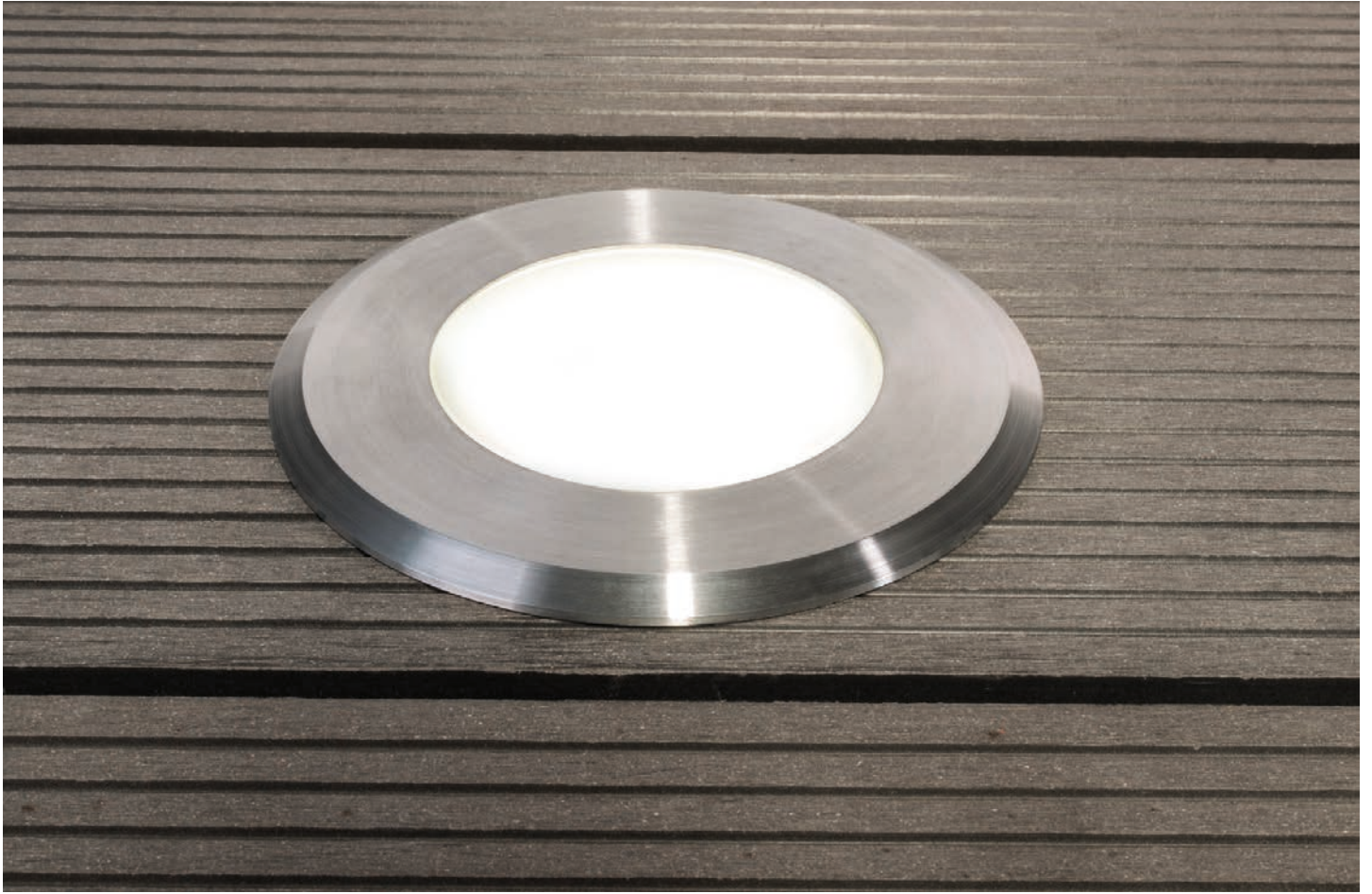

HOLM
SEGNAPASSO
WALKOVER LIGHT

BTL CATEGORIA SCONTO 24

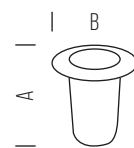

DIMENSIONI	A	B
1	125	118.6
2	139	118.6



IT

- Apparecchio segnapasso calpestabile da terrazza adattabile ad ambienti interni ed esterni
- Utilizzato per illuminazione d'accento
- Disponibile in due versioni con fascio singolo o tre fasci laterali
- Colorazione anello frontale: acciaio inossidabile
- Monta una sorgente led con attacco GU10 - 6W max (non inclusa)
- Non necessita di cassa

EN

- Walkover lights for terraces suitable for indoor or outdoor environments
- Used for accent lighting
- Available in two versions with single or 3-way side beams
- Top ring colour: stainless steel
- Requires a led light source with GU10 base - 6W max (not included)
- No recess required

IP65

CLASS I

POTENZA WATT	BASE	KELVIN	LUMEN LM	FASCIO °	MISURE MM	VARIANTE	CODICE	EAN	IMBALLO	€ IVA ESCLUSA
-	GU10	-	-	-	1	ACCIAIO / STEEL	4510237	6435200209023	1/10	63,60
-	GU10	-	-	-	2	ANTRACITE / ANTHRACITE	4510253	6435200217288	1/10	55,12



GARDA

LAMPADE DA GIARDINO
OUTDOOR GARDEN LAMPS

BTL CATEGORIA SCONTO 24

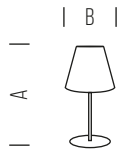

DIMENSIONI	A	B
1	530	280
2	1500	350



IT

- Utilizzabile in esterno su patii, terrazze o balconi.
- Adatto all'interno, ad esempio in hall e corridoi.
- Corpo realizzato in metallo verniciato a polveri.
- Disponibile in due diverse altezze
- Cavo di alimentazione con spina incluso
- Monta una sorgente led con attacco E27 - 40W max (non inclusa)
- Diffusore di materiale plastico con protezione UV
- Dotato di interruttore ON/OFF

EN

- Useable outdoors on patios, terraces or balconies.
- Suitable for indoors, e.g. in halls and corridors.
- Made from metal with powder-coated paint finish.
- Available in two heights.
- Power cable with plug included
- Requires a led light source with E27 base - 40W max (not included)
- Plastic diffusor with UV protection
- Fitted with ON/OFF switch



POTENZA WATT	BASE	KELVIN	LUMEN LM	FASCIO °	MISURE MM	VARIANTE	CODICE	EAN	IMBALLO	€ IVA ESCLUSA
-	E27	-	-	-	1		4289789	6435200203113	1	116,60
-	E27	-	-	-	2		4289790	6435200203137	1	180,20

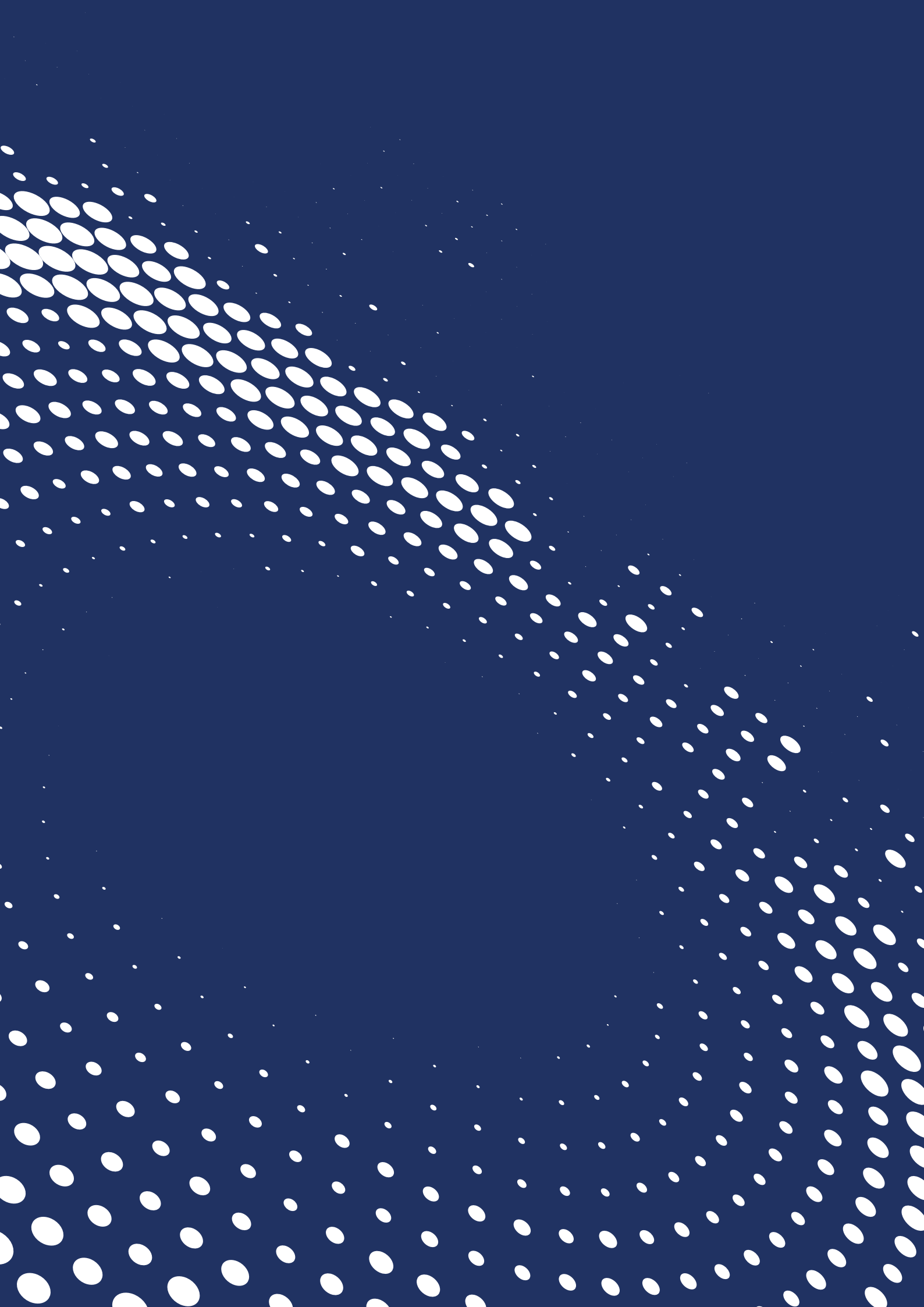

A decorative graphic in the bottom-left corner consisting of a series of white dots of varying sizes, arranged in a pattern that suggests a sunburst or a field of stars, fading out towards the center of the page.

SOLARI
SOLARS

FLAME2N

TORCIA A LED EFFETTO FIAMMA - SOLARE CON SENSORE CREPUSCOLARE
 LED TORCH WITH FLAME EFFECT - SOLAR POWERED & DUSK SENSOR

BTL CATEGORIA SCONTO 24

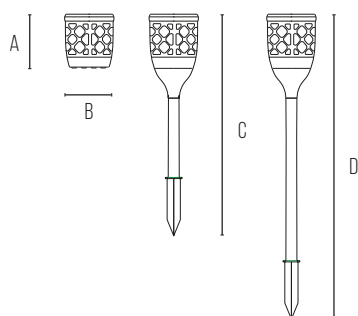

DIMENSIONI	A	B	C	D
1	127	Ø114,2	517	706



IT

- Fiamma unica e realistica
- Fissaggio semplice del supporto che permette di passare da illuminazione a palo, a lampada portatile
- Multifunzione:
 - Paletto da esterno per giardino o terrazze
 - Lampada decorativa da interno per creare atmosfera
- Due differenti modi di funzionamento
- Può essere ricaricata tramite pannello solare o porta USB (micro USB)
- Pannello solare di alta qualità ai cristalli di silicio, alta efficienza di conversione fotoelettrica
- Batteria al Litio ad alte prestazioni con più ampia capacità e più lunga durata
- Prodotta in materiale resistente ai raggi UV per maggiore durabilità
- Protezione IP65
- Colore nero

FUNZIONAMENTO

Luce a LED da giardino ad effetto fiamma, ad energia solare IP65.

Dotata di sensore crepuscolare, ha due modalità di funzionamento. Premendo il pulsante di accensione una volta si entra in modalità A con potenza di 0,5W, si accende al crepuscolo (≤ 30 lux) e si spegne all'alba (≥ 150 lux).

Premendo il pulsante una seconda volta, entra in modalità B e si accende al 100% di emissione luminosa a 2W di potenza, si accende al crepuscolo (≤ 30 lux) e si spegne all'alba (≥ 150 lux) oppure ad esaurimento carica.

OPERATION

LED garden light with flame effect, solar powered and IP65.

Equipped with a dusk sensor, it has two operating modes. Pressing the power button once enters mode A with a power of 0.5W, turns on at dusk (≤ 30 lux) and turns off at dawn (≥ 150 lux).

By pressing the button twice, it enters mode B with 2W (100% of power) and turns on at dusk (≤ 30 lux) and turns off at dawn (≥ 150 lux) or when the battery is low.

EN

- Unique and realistic flame
- Simple fixing of the support that allows you to switch between pole lighting and portable lamp
- Multifunction:
 - Outdoor bollard for garden or terraces
 - Decorative indoor lamp that create atmosphere
- Two different operating modes
- It can be recharged via solar panel or USB port (micro USB)
- High quality silicon crystal solar panel, high photoelectric conversion efficiency
- High performance lithium battery with wider capacity and longer life
- Made of UV-resistant material for durability
- IP65 protection
- Black finishing



POTENZA WATT	BASE	KELVIN	LUMEN LM	FASCIO °	MISURE MM	VARIANTE	CODICE	EAN	IMBALLO	€ IVA ESCLUSA
2	-	1500	-	360	1	-	FLAME2N	8031453023232	1/2	37,10
BATTERIA DI RICAMBIO / REPLACEMENT BATTERY						-	FLAME2BAT	8031453024208	1	3,92



YUMA2N
PROIETTORE SOLARE
SOLAR FLOODLIGHT

BTL CATEGORIA SCONTO 24

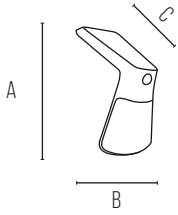

DIMENSIONI	A	B	C
1	200	105	90



FUNZIONAMENTO

- Quando la batteria è carica (>30%), la lampada si accende alla massima luminosità (240lm) quando il sensore rileva ad un distanza ≤ 6 m un movimento. Dopo 10 secondi senza rilevamento, automaticamente si posiziona al 20% con luce frontale e posteriore.
- Quando la batteria è al di sotto del 30% di carica, la lampada si accende alla massima luminosità (240lm) quando il sensore rileva ad un distanza ≤ 6 m un movimento. Dopo 10 secondi senza rilevamento, automaticamente la lampada si spegne.

OPERATION

- When the battery is charged (>30%), the light switches on at maximum brightness (240 lm) when the sensor detects a movement at a distance of ≤ 6 m. After 10 seconds with no movement detected, the front and rear brightness automatically reduces to 20%
- When the battery has less than 30% charge, the light switches on at maximum brightness (240 lm) when the sensor detects a movement at a distance of ≤ 6 m. After 10 seconds with no movement detected, the light automatically switches off.

IT

- Wall Light con sensore crepuscolare e rilevatore di presenza PIR
- Facile Installazione: non richiede collegamento alla rete elettrica.
- Luce di cortesia indiretta sempre accesa di notte
- Batteria Litio 3,7V-1200mAh
- Colore nero

EN

- Wall light with PIR motion and dusk sensor
- Easy to install: does not require connection to mains energy.
- Indirect courtesy light always on at night
- Lithium battery 3.7V-1200mAh
- Black finishing

IP65

30.000 H

INSTANT

CLASS III

-15° **+45°**

PIR

NOT DIMMABLE

POTENZA WATT	BASE	KELVIN	LUMEN LM	FASCIO °	MISURE MM	VARIANTE	CODICE	EAN	IMBALLO	€ IVA ESCLUSA
2	-	4000	240	90	1	-	YUMA2N	8031453020699	1/24	26,50

YUMA5N
PROIETTORE SOLARE
SOLAR FLOODLIGHT

BTL CATEGORIA SCONTO 24

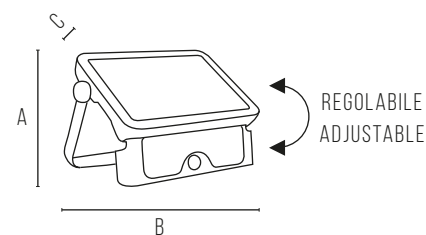

DIMENSIONI	A	B	C
1	217	150	33



FUNZIONAMENTO

- Quando la carica della batteria è >30%, automaticamente passa alla massima emissione in caso di intervento del sensore nel raggio 6 m, per poi passare dopo 20 secondi alla luce di cortesia al 20% dell'intensità. Se la carica della batteria è inferiore al 30% automaticamente passa alla massima emissione in caso di intervento del sensore nel raggio 6 m, per poi spegnersi completamente dopo 20 secondi.

- Premere il pulsante per più di 3 secondi e il proiettore passa a luce massima costante; il sensore sia crepuscolare che di presenza è disattivato. Mantiene la luce accesa al massimo dell'emissione sino a completa scarica della batteria.

OPERATION

- When the battery has more than 30% charge, the light automatically switches on at maximum brightness if the sensor detects movement within a radius of 6m, after 20 seconds it then switches to the courtesy light at 20% brightness. If the battery has less than 30% charge, the light automatically switches on at maximum brightness if the sensor detects movement within a radius of 6m, it then switches off completely after 20 seconds

- By pressing the button for more than 3 seconds the light switches on constantly at the maximum brightness; both the dusk and movement sensors are deactivated. The light shall remain on at maximum brightness until the battery loses its charge.

IT

- Proiettore con sensore crepuscolare e rilevatore di presenza PIR
- Facile Installazione: non richiede collegamenti alla rete elettrica.
- Batteria Litio 3,7V-3000mAh
- Colore nero

EN

- Floodlight with crepuscular sensor and PIR motion detector
- Easy to install: does not require connection to mains energy.
- Lithium battery 3.7V-3000mAh
- Black finishing



POTENZA WATT	BASE	KELVIN	LUMEN LM	FASCIO °	MISURE MM	VARIANTE	CODICE	EAN	IMBALLO	€ IVA ESCLUSA
5	-	4000	500	90	1	-	YUMA5N	8031453020347	1/18	47,70
BATTERIA DI RICAMBIO / REPLACEMENT BATTERY						-	YUMA5BAT	8031453020361	1	11,66

YUMA10N
PROIETTORE SOLARE
SOLAR FLOODLIGHT

BTL CATEGORIA SCONTO 24

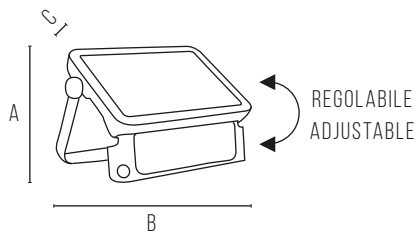

DIMENSIONI	A	B	C
1	300	215	35



FUNZIONAMENTO

MODE A (Pulsante per il 20% di luce costante)

Al crepuscolo (<30 Lux) il proiettore **si accende automaticamente e rimane al 20% dell'emissione** sino all'alba o al termine della carica della batteria.

MODE B (Pulsante per 100% / 20%)

Al crepuscolo (<30 Lux) il proiettore si accende automaticamente in modalità 20%. **In caso di rilevamento di movimento si accende al massimo dell'emissione** e torna al 20% dopo 20 secondi in caso di non rilevamento.

MODE C (Pulsante massima emissione-Spento)

Dopo il crepuscolo si accende al Massimo dell'emissione in caso di rilevamento di movimento. Se non rileva più movimento **si spegne completamente dopo 20 secondi**.

OPERATION

MODE A (Button for 20% constant light)

At twilight (<30 Lux) the floodlight **switches on automatically and remains at 20% brightness** until sunrise or until the battery loses its charge.

MODE B (Button for 100% / 20%)

At twilight (<30 Lux) the floodlight switches on automatically at 20% brightness. **If movement is detected it switches to maximum brightness** and returns to 20% after 20 seconds of no movement being detected.

MODE C (Button for maximum brightness - Off)

After twilight it switches on at maximum brightness if movement is detected.

If no further movement is detected it switches off completely after 20 seconds.

IT

- Proiettore con sensore crepuscolare e doppio rilevatore di presenza PIR
- Facile Installazione: non richiede collegamento alla rete elettrica.
- Batteria Litio 3,7V-7200mAh
- Colore nero

EN

- Floodlight with dusk sensor and double PIR motion detector
- Easy to install: does not require connection to mains energy.
- Lithium battery 3.7V-7200mAh
- Black finishing



35.000 H



-15° +40°



POTENZA WATT	BASE	KELVIN	LUMEN LM	FASCIO °	MISURE MM	VARIANTE	CODICE	EAN	IMBALLO	€ IVA ESCLUSA
10	-	4000	1080	90	1	-	YUMA10N	8031453019846	1/8	94,34
BATTERIA DI RICAMBIO / REPLACEMENT BATTERY						-	YUMA10BAT	8031453020354	1	27,56





FUNZIONAMENTO

Il proiettore ha funzionalità differenti se il pannello solare è collegato o scollegato (senza pannello solare vengono automaticamente escluse le funzioni crepuscolare e presenza)

Pannello solare scollegato:

Premere il tasto ON/OFF la prima volta per avere il 50% di flusso luminoso(550 lumen);
Premere il tasto ON/OFF la seconda volta per avere il 100% di flusso luminoso (1100 lumen);
Premere il tasto ON/OFF la terza volta per spegnere il proiettore.

Pannello solare collegato:

MODO A:

Premere il tasto ON/OFF la prima volta: dopo il crepuscolo si accende al massimo dell'emissione in caso di rilevamento di movimento nel raggio $\leq 8m$. Se non rileva nessun movimento passa al 5% della luminosità dopo 20 secondi.

MODO B:

Premere il tasto ON/OFF la seconda volta: dopo il crepuscolo si accende al massimo dell'emissione. Dopo 5 ore o con carica della batteria inferiore al 30%, passa automaticamente al Modo A.
Premere il tasto ON/OFF la terza volta per spegnere il proiettore.

OPERATION

The projector has different functions if the solar panel is connected or disconnected (without solar panel connected, the floodlight is uncontrolled by sunlight and microwave sensor)

Solar panel disconnected:

Press ON/OFF Button 1st time, turn on with 50% brightness (550 lumen);
Press ON/OFF Button 2nd time, switch to 100% brightness (1100 lumen);
Press ON/OFF Button 3rd time to turn off the floodlight.

Solar panel connected:

MODE A:

Press ON/OFF Button 1st time: automatically turns on to 100% brightness at night when motion is detected in the range $\leq 8m$, then dim to 5% brightness in 20 seconds if no motion detected.

MODE B:

Press ON/OFF Button 2nd time: automatically turns on at night and keep 100% brightness; after 5 hours of working or when the battery capacity is below 30%, it will turn to Mode A.
Press ON/OFF Button 3rd time to turn off the floodlight.

YUMA 10NS

PROIETTORE SOLARE CON PANNELLO ESTERNO
FLOODLIGHT WITH EXTERNAL SOLAR PANEL

BTL CATEGORIA SCONTO 24

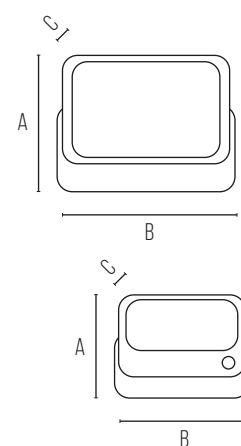

DIMENSIONI	A	B	C
PROIETTORE	232	166	34
PANNELLO	345	236	25



IT

- Proiettore con sensore crepuscolare e rilevatore di presenza PIR
- Facile Installazione: non richiede collegamenti alla rete elettrica.
- Batteria Litio 3,7V-7200mAh
- Pannello solare a due facce in silicio monocristallino collegato mediante connettore rapido
- Il proiettore può essere separato dal pannello ed utilizzato in modalità standalone con eventuale ricarica mediante presa Micro USB
- Funzione powerbank con uscita USB e indicatore di carica batteria.
- 4 modalità di funzionamento selezionabili.
- Lunghezza cavo di connessione: 3m
- Colore nero

EN

- Floodlight with dusk sensor and PIR motion detector
- Easy to install: does not require connection to mains.
- Lithium battery 3,7V-7200mAh
- Double-sided solar panel in monocrystalline silicon connected by quick connector
- The floodlight may be separated from the panel and used in standalone mode with recharge possible through Micro USB jack
- Powerbank function with USB outlet and battery charge indicator.
- 4 operating modes.
- Connection cable length: 3m
- Black finishing

IP65

35.000 H

INSTANT

CLASS III

-15° +40°

PIR

USB

NOT DIMMABLE

POTENZA WATT	BASE	KELVIN	LUMEN LM	FASCIO °	MISURE MM	VARIANTE	CODICE	EAN	IMBALLO	€ IVA ESCLUSA
10	-	4000	1100	90	1	-	YUMA 10NS	8031453022617	1/10	116,60
BATTERIA DI RICAMBIO / REPLACEMENT BATTERY						-	YUMA 10BAT	8031453020354	1	27,56

YUMA20NP

PALETTO SOLARE DA GIARDINO SOLAR BOLLARD GARDEN LIGHT

BTL CATEGORIA SCONTO 24



DIMENSIONI	A	B	C
1	800	220	90



FUNZIONAMENTO

Ogni lato è dotato di un tasto con cui impostare la modalità di funzionamento, pertanto i due lati sono indipendenti.

Il dispositivo si ricarica in qualsiasi modalità di funzionamento.

Premendo il pulsante la prima volta si attiva la modalità sensore, la quale accenderà il lato interessato del paletto al crepuscolo, quando il sensore rileva un movimento nel raggio di 8 m si attiva alla massima emissione (1000 lumen nel lato interessato), per poi passare alla luce di cortesia (150 lumen per lato) dopo 20 secondi senza nessuna rilevazione.

Premendo il pulsante la seconda volta si attiva la modalità a luce costante, la quale accenderà il lato interessato del paletto al crepuscolo al 50% dell'emissione (500 lumen per lato) fino all'alba o all'esaurimento della batteria (sensore escluso).

Premendo il pulsante la terza volta il paletto si spegnerà.

OPERATION

Each side of the bollard has a button to select the working mode for each side, so press the button to select the working mode for each side individually. The fixture can be charged with solar power in any working mode.

Press the button 1st time to enable the sensor mode, at night automatically turns on to full brightness (1000 lumen on one side) when motion is detected in the range ≤ 8 m and then turns to courtesy brightness (150 lumen on one side) in 20 seconds of no motion.

Press the button 2nd time to enable the constant light mode, at night automatically turns on and keeps half of max brightness (500 lumen on one side) till it's dawn or low battery (sensor excluded).

Press the button 3rd time to turn OFF the fixture.

IT

- Paletto da giardino a doppia emissione (LED 2x10W) con doppio sensore crepuscolare e rilevatore di presenza PIR
- Illuminazione a singolo o doppio lato selezionabile
- 2 Modalità di funzionamento differenti selezionabili separatamente per ogni lato
- Pannello solare oversize a doppia faccia in silicio monocristallino
- Corpo in fusione di alluminio (colore antracite)

EN

- Double emission bollard (LED 2x10W) with double dusk sensor and PIR presence detector
- Selection of light on one or both sides
- Selection of 2 modes of operation separately for each side
- Oversize double-sided solar panel in monocrystalline silicon
- Die-cast aluminium body (anthracite finishing)

IP65

30.000 H

INSTANT

CLASS III

-15° +40°

PIR

NOT DIMMABLE

POTENZA WATT	BASE	KELVIN	LUMEN LM	FASCIO °	MISURE MM	VARIANTE	CODICE	EAN	IMBALLO	€ IVA ESCLUSA
20	-	4000	2000	120	1	-	YUMA20NP	8031453022624	1/4	286,20
BATTERIA DI RICAMBIO / REPLACEMENT BATTERY						-	YUMA20NPBAT	8031453024734	1	55,65





YUMA15N
PROIETTORE SOLARE
SOLAR FLOODLIGHT

BTL CATEGORIA SCONTO 24

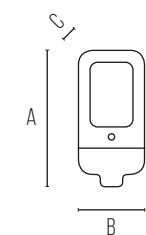

DIMENSIONI	A	B	C
1	413	232	58



FUNZIONAMENTO

Quando il sensore rileva un movimento nel raggio di 8m, il proiettore si accende alla massima emissione (1600 lm) per poi tornare al 20% dopo 20 secondi.

Dopo 5 ore di funzionamento o con la batteria al di sotto del 30% di carica, automaticamente il proiettore si posiziona in modalità risparmio energetico: quando il sensore rileva un movimento nel raggio di 8m, il proiettore si accende alla massima emissione (1600 lm) per poi tornare al 20% dopo 20 secondi e spegnersi completamente dopo 5 minuti.

OPERATION

When the sensor detects a movement within a range of 8 m, the floodlight switches on at maximum brightness (1600 lm), returning to 20% after 20 seconds.

Following 5 hours of operation or with the battery at less than 30% charge, the floodlight automatically switches to energy saving mode: when the sensor detects a movement within a radius of 8 m, the floodlight switches on at maximum brightness (1600 lm), returns to 20% after 20 seconds and then switches off completely after 5 minutes.

IT

- Proiettore con sensore crepuscolare e rilevatore di presenza PIR
- Facile Installazione: non richiede collegamento alla rete elettrica.
- Batteria Litio 2x 3,7V-5400mAh
- Staffa di fissaggio inclusa
- Colore nero

EN

- Floodlight with dusk sensor and PIR motion detector
- Easy to install: does not require connection to mains energy.
- Lithium battery 2x 3,7V-5400mAh
- Fixing bracket included
- Black finishing

IP65

35.000 H

INSTANT

CLASS III

-15° +40°

PIR

NOT DIMMABLE

POTENZA WATT	BASE	KELVIN	LUMEN LM	FASCIO °	MISURE MM	VARIANTE	CODICE	EAN	IMBALLO	€ IVA ESCLUSA
15	-	4000	1600	90	1	-	YUMA 15N	8031453020705	1/5	104,94
BATTERIA DI RICAMBIO / REPLACEMENT BATTERY						-	YUMA15BAT	8031453022778	1	39,22

YUMA40N

PROIETTORE SOLARE STRADALE A LED CON TELECOMANDO SOLAR LED STREET FLOODLIGHT WITH REMOTE CONTROL

BTL CATEGORIA SCONTO 24

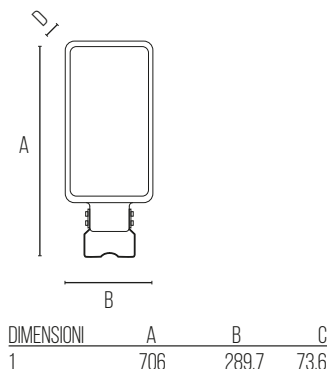

FUNZIONAMENTO

Il proiettore può essere impostato in due modalità di funzionamento: modo A "Luce Costante", modo B "Modo Sensore".

Premere il pulsante sull'apparecchio 1 volta ☀ o sul telecomando, la luce si accenderà automaticamente alla notte mantenendo costantemente il 60% del flusso luminoso per 4 ore (sensore escluso). Dopo questo periodo passerà automaticamente al modo sensore (B).

Premere il pulsante sull'apparecchio 2 volte ☀ o sul telecomando, la luce si accenderà automaticamente al 100% alla sera in caso di rilevamento nel raggio di 12 m per poi passare al 30% dopo 20 secondi in cui il sensore non rileva presenza.

Con il telecomando alcuni parametri possono essere modificati, si rimanda al manuale di istruzioni per maggiori dettagli.

OPERATION

Floodlight can be set in two different ways: mode A "Constant Light" and mode B "Sensor Mode".

Press button on the lamp 1st time ☀ or on the remote control, the lamp will automatically turn on at night and keep 60% of brightness constantly for 4 hours (sensor excluded), then it turns to sensor mode (B).

Press button on the lamp 2nd time ☀ or on the remote control, the lamp will automatically turn on with 100% full brightness when motion is detected in the range ≤ 12 mtrs, then turns to 30% brightness in 20 seconds of no motion.

With remote control some parameters can be adjusted, please refer to instruction manual for details.

IT

- Proiettore con sensore crepuscolare e rilevatore di presenza
- Facile installazione: non richiede collegamento alla rete elettrica.
- Design brevettato, elegante, compatto duraturo e facile da installare
- Corpo in ABS colore nero ad alta resistenza e diffusore in PC di alta qualità, IP65, autoestinguenza UL-V0
- Dotato di lenti ottiche per l'ottimizzazione del flusso luminoso. Anti UV
- Pannello solare in silicio mono cristallino di alta qualità.
- Alto potere di conversione foto-elettrica e lunga durata
- Utilizza SMD LED di ultima generazione ad alta luminosità, bassa decadenza e lunga durata
- Batteria al Litio 9,6V-12000mAh ad alte prestazioni con più ampia capacità e più lunga durata
- 2 modalità di funzionamento

EN

- Floodlight with dusk sensor and presence detector
- Easy installation: does not require connection to the network electricity.
- Patented design, elegant, compact, durable and easy to install
- High resistance black colour ABS body and high PC diffuser
- quality, IP65, self-extinguishing UL-V0
- Equipped with optical lenses for luminous flow optimization Anti UV
- High quality mono-crystalline silicon solar panel.
- High photo-electric conversion power and long life
- Uses the latest generation of high brightness SMD LEDs low decay and long life
- 9,6V-12000mAh high performance lithium battery with more large capacity and longer life
- 2 operating modes



POTENZA WATT	BASE	KELVIN	LUMEN LM	FASCIO °	MISURE MM	VARIANTE	CODICE	EAN	IMBALLO	€ IVA ESCLUSA
40	-	4000	4800	140X70	1	-	YUMA40N	8031453023225	1/4	316,94
BATTERIA DI RICAMBIO / REPLACEMENT BATTERY						-	YUMA40BAT	8031453024192	1	118,72



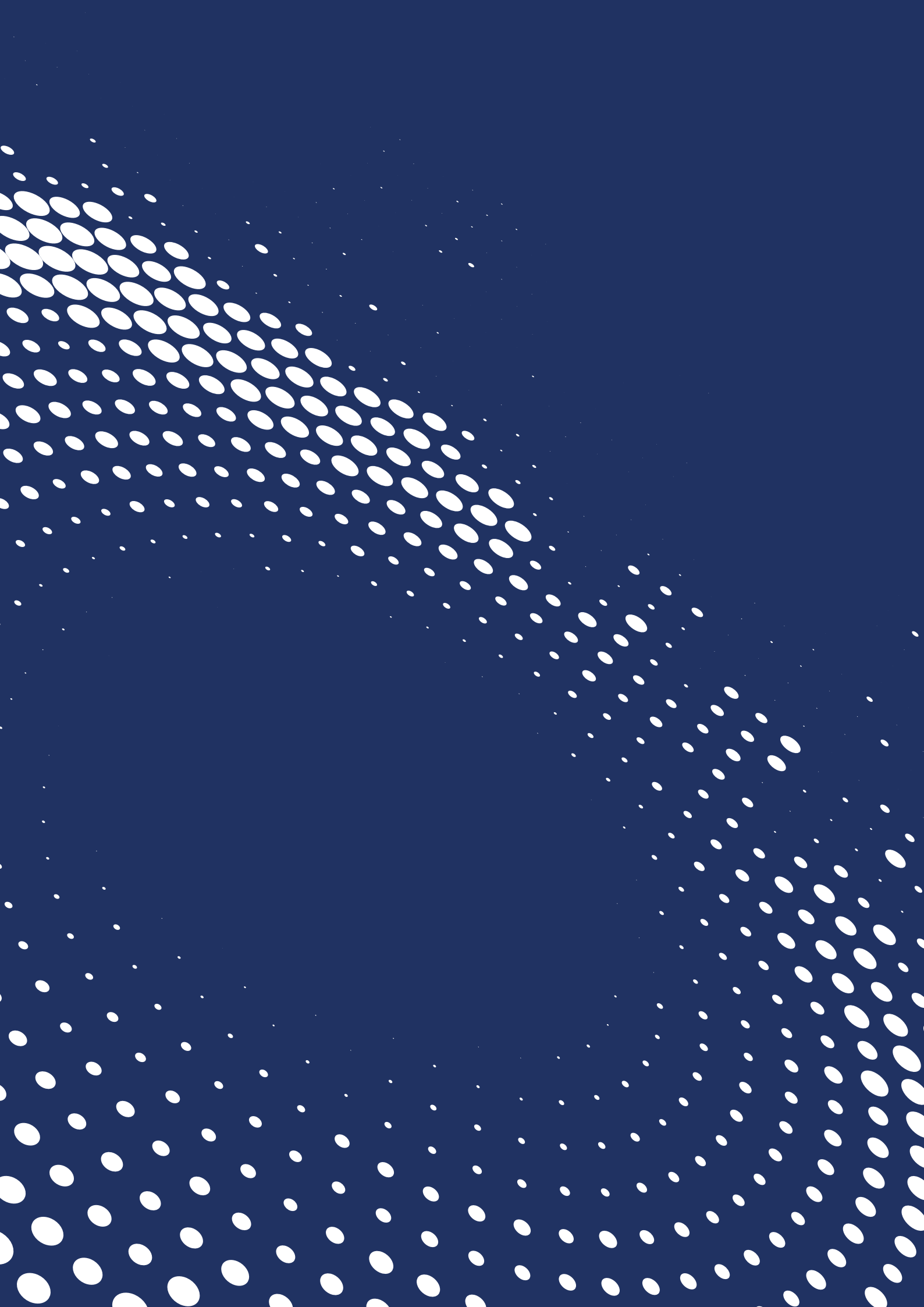

A decorative graphic in the bottom-left corner consisting of a series of white dots of varying sizes, arranged in a pattern that suggests a fan or a cluster of particles.

INDOOR TECNICO
TECHNICAL INDOOR

PANNELLO LED 600X600 A ELEVATO COMFORT VISIVO
600X600 LED PANEL WITH HIGH VISUAL COMFORT

BTL CATEGORIA SCONTO 23

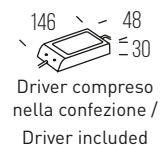
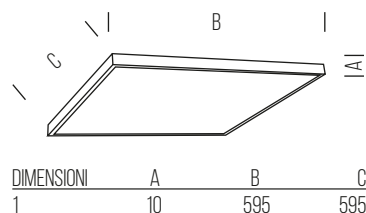

IT

- Pannello LED spessore 10mm ad illuminazione laterale
- Progettato per il massimo comfort visivo: basso abbagliamento UGR<19 e alta resa cromatica CRI>90
- Cornice in alluminio verniciato bianco RAL9016
- Protezione frontale IP40 (posteriore IP20)
- Driver separato flicker-free con connettore rapido DC
- In opzione: KIT per montaggio a plafone, sospensione ed incasso
- In opzione: KIT emergenza con montaggio semplificato tramite connettori DC

EN

- LED panel 10mm thick with side light source
- Engineered for highest viewing comfort: low glare UGR<19 and high chromatic rendering CRI>90
- Frame in aluminium with white paint finish RAL9016
- Front protection IP40 (rear IP20)
- Separate flicker-free driver with quick fit DC power connector
- Optional: KIT for surface mounting, suspension and recessed
- Optional: emergency KIT for easy assembly using DC power connectors

IP40
220V 240V
25.000H
INSTANT
CLASS II
-20° * +40°
CRI>90
UGR <19
NOT DIMMABLE

POTENZA WATT	BASE	KELVIN	LUMEN LM	FASCIO °	MISURE MM	VARIANTE	CODICE	EAN	IMBALLO	€ IVA ESCLUSA
38	-	3000	3200	90	1	UGR<19	LD3PAN3852U9	8031453022952	1/6	66,78
38	-	4000	3400	90	1	UGR<19	LD3PAN3853U9	8031453022969	1/6	66,78

PANNELLO LED 600X600 ALTA EFFICIENZA 100LM/W
HIGH EFFICIENCY 600X600 LED PANEL 100LM/W

BTL CATEGORIA SCONTO 23

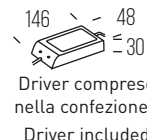
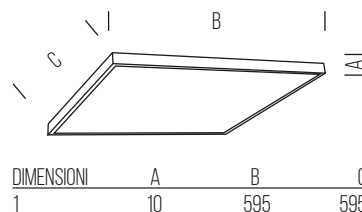

IT

- Pannello LED spessore 10mm ad illuminazione laterale
- Cornice in alluminio verniciato bianco RAL9016
- Protezione frontale IP40 (posteriore IP20)
- Driver separato flicker-free con connettore rapido DC
- In opzione: KIT per montaggio a plafone, sospensione ed incasso
- In opzione: KIT emergenza con montaggio semplificato tramite connettori DC
- In opzione: driver dimmerabile 1-10V e DALI

EN

- LED panel 10mm thick with side light source
- Frame in aluminium with white paint finish RAL9016
- Front protection IP40 (rear IP20)
- Separate flicker-free driver with quick fit DC power connector
- Optional: KIT for surface mounting, suspension and recessed
- Optional: emergency KIT for easy assembly using DC power connectors
- Optional: dimmable driver 1-10V and DALI

POTENZA WATT	BASE	KELVIN	LUMEN LM	FASCIO °	MISURE MM	VARIANTE	CODICE	EAN	IMBALLO	€ IVA ESCLUSA
38	-	3000	3800	110	1	-	LD3PAN3852	8031453021740	1/6	56,18
38	-	4000	3800	110	1	-	LD3PAN3853	8031453021757	1/6	56,18
38	-	6500	3800	110	1	-	LD3PAN3851	8031453024697	1/6	56,18
38	-	4000	3800	90	1	UGR<19	LD3PAN3853U	8031453021771	1/6	64,66

PANNELLO LED 300X1200 ALTA EFFICIENZA 100LM/W
HIGH EFFICIENCY 300X1200 LED PANEL 100LM/W

BTL CATEGORIA SCONTO 23

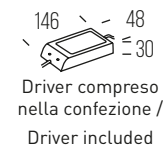
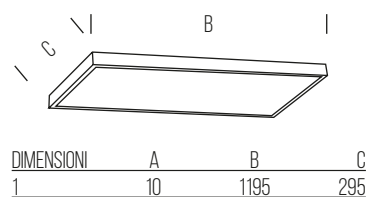

IT

- Pannello LED spessore 10mm ad illuminazione laterale
- Cornice in alluminio verniciato bianco RAL9016
- Protezione frontale IP40 (posteriore IP20)
- Driver separato flicker-free con connettore rapido DC
- In opzione: KIT per montaggio a plafone, sospensione ed incasso
- In opzione: KIT emergenza con montaggio semplificato tramite connettori DC
- In opzione: driver dimmerabile 1-10V e DALI

EN

- LED panel 10mm thick with side light source
- Frame in aluminium with white paint finish RAL9016
- Front protection IP40 (rear IP20)
- Separate flicker-free driver with quick fit DC power connector
- Optional: KIT for surface mounting, suspension and recessed
- Optional: emergency KIT for easy assembly using DC power connectors
- Optional: dimmable driver 1-10V and DALI



25.000 H

INSTANT

CLASS II

-20° +40°



POTENZA WATT	BASE	KELVIN	LUMEN LM	FASCIO °	MISURE MM	VARIANTE	CODICE	EAN	IMBALLO	€ IVA ESCLUSA
38	-	4000	3800	110	1	-	LD3PAN3853B	8031453021764	1/6	63,60
38	-	4000	3800	90	1	UGR<19	LD3PAN3853UB	8031453021788	1/5	71,02

PANNELLO LED 300X1200 A ELEVATO COMFORT VISIVO
300X1200 LED PANEL WITH HIGH VISUAL COMFORT

NEW

BTL CATEGORIA SCONTO 23



DIMENSIONI	A	B	C
1	10	1195	295



Driver compreso
nella confezione /
Driver included



IT

- Pannello LED spessore 10mm ad illuminazione laterale
- Progettato per il massimo comfort visivo: basso abbagliamento UGR<19 e alta resa cromatica CRI>90
- Cornice in alluminio verniciato bianco RAL9016
- Protezione frontale IP40 (posteriore IP20)
- Driver separato flicker-free con connettore rapido DC
- In opzione: KIT per montaggio a plafone, sospensione ed incasso
- In opzione: KIT emergenza con montaggio semplificato tramite connettori DC
- In opzione: driver dimmerabile 1-10V e DALI

EN

- LED panel 10mm thick with side light source
- Engineered for highest viewing comfort: low glare UGR<19 and high chromatic rendering CRI>90
- Frame in aluminium with white paint finish RAL9016
- Front protection IP40 (rear IP20)
- Separate flicker-free driver with quick fit DC power connector
- Optional: KIT for surface mounting, suspension and recessed
- Optional: emergency KIT for easy assembly using DC power connectors
- Optional: dimmable driver 1-10V and DALI



POTENZA WATT	BASE	KELVIN	LUMEN LM	FASCIO °	MISURE MM	VARIANTE	CODICE	EAN	IMBALLO	€ IVA ESCLUSA
40	-	4000	3400	90	1	CRI>90 - UGR<19	LD3PAN3853UB9	8031453025045	1	78,79

PANNELLO LED 600X600 ALTISSIMA EFFICIENZA 110LM/W UGR<19

LED PANEL 600X600 VERY HIGH EFFICIENCY 110LM/W UGR <19

BTL CATEGORIA SCONTO 23

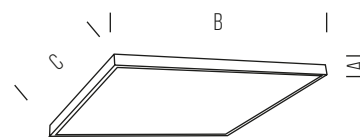

DIMENSIONI	A	B	C
1	10	595	595



Driver compreso
nella confezione /
Driver included



IT

- Pannello LED spessore 10mm ad illuminazione laterale
- Altissima Efficienza 110lm/W
- Lunga durata prevista 50.000h
- LGP in PMMA non ingiallisce garanzia 5 anni
- Cornice in alluminio verniciato bianco RAL9016
- Protezione frontale IP40 (posteriore IP20)
- Driver separato flicker-free con connettore rapido DC
- In opzione: KIT per montaggio a plafone, sospensione ed incasso
- In opzione: KIT emergenza con montaggio semplificato tramite connettori DC

EN

- LED panel 10mm thick with side light source
- Very high efficiency 110lm/W
- Long life 50,000h
- Light guide plate in non-yellowing PMMA 5-year warranty
- Frame in aluminium with white paint finish RAL9016
- Front protection IP40 (rear IP20)
- Separate flicker-free driver with quick fit DC power connector
- Optional: KIT for surface mounting, suspension and recessed
- Optional: Emergency KIT for easy assembly using DC power connectors

IP40

220v
240v

50.000 H

INSTANT

-20° +40°

UGR<19

NOT
DIMMABLE

POTENZA WATT	BASE	KELVIN	LUMEN LM	FASCIO °	MISURE MM	VARIANTE	CODICE	EAN	IMBALLO	€ IVA ESCLUSA
45	-	3000	5000	90	1	UGR<19	LD3PAN4552U	8031453022631	1/6	98,58
45	-	4000	5000	90	1	UGR<19	LD3PAN4553U	8031453022648	1/6	98,58

PANNELLO LED RETROILLUMINATO 600X600 ALTA EFFICIENZA 100LM/W

HIGH EFFICIENCY 600X600 BACKLIT LED PANEL 100LM/W

BTL CATEGORIA SCONTO 23

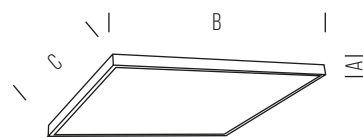

DIMENSIONI	A	B	C
1	34	595	595

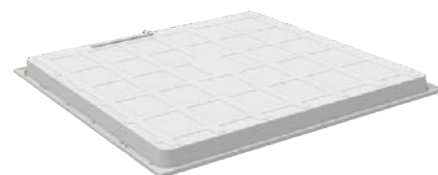

IT

- Pannello LED retroilluminato
- Non necessita di LGP
- Cornice in alluminio verniciato bianco RAL9016
- Driver isolato integrato nel corpo dell'apparecchio
- In opzione: KIT per montaggio a plafone, sospensione ed incasso

EN

- Backlit LED panel
- Light guide plate not required
- Frame in aluminium with white paint finish RAL9016
- Isolated driver incorporated in luminaire
- Optional: KIT for surface mounting, suspension and recessed

IP20

**220v
240v**

25.000 H

INSTANT

CLASS II

-10° +45°

NOT DIMMABLE

POTENZA WATT	BASE	KELVIN	LUMEN LM	FASCIO °	MISURE MM	VARIANTE	CODICE	EAN	IMBALLO	€ IVA ESCLUSA
36	-	3000	3600	110	1	-	LD4PAN3652	8031453022037	1/4	42,40
36	-	4000	3600	110	1	-	LD4PAN3653	8031453022044	1/4	42,40

PANNELLO LED RETROILLUMINATO 600X600 ALTA EFFICIENZA 90LM/W - UGR <19

HIGH EFFICIENCY 600X600 BACKLIT LED PANEL 90LM/W - UGR <19

NEW

BTL CATEGORIA SCONTO 23

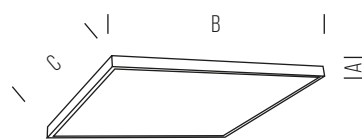

DIMENSIONI	A	B	C
1	34	595	595



Driver compreso
nella confezione /
Driver included

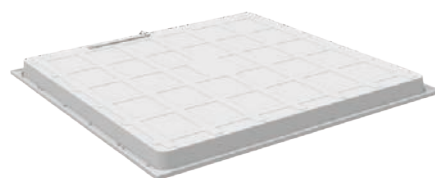

IT

- Pannello LED retroilluminato
- Progettato per il massimo comfort visivo: basso abbagliamento UGR<19
- Non necessita di LGP
- Cornice in alluminio verniciato bianco RAL9016
- Driver separato con connettore rapido DC
- In opzione: KIT per montaggio a plafone, sospensione ed incasso

EN

- Backlit LED panel
- Engineered for highest viewing comfort: low glare UGR<19
- Light guide plate not required
- Frame in aluminium with white paint finish RAL9016
- Separate driver with quick fit DC power connector
- Optional: KIT for surface mounting, suspension and recessed

IP20

220v
240v

30.000 H

INSTANT

CLASS II

-10° +45°

NOT DIMMABLE

UGR<19

POTENZA WATT	BASE	KELVIN	LUMEN LM	FASCIO °	MISURE MM	VARIANTE	CODICE	EAN	IMBALLO	€ IVA ESCLUSA
36	-	4000	3240	90	1	UGR<19	LD4PAN3653U	8031453024871	1/4	46,12



LED DRIVER CORRENTE COSTANTE PER LED PANEL

CONSTANT CURRENT LED DRIVER FOR LED PANEL

BTL CATEGORIA SCONTO 23



LD3PAND38



LD3PAND40



LD3PAND45



LD3PAND42D



DIMENSIONI DRIVER	D	E	F
1	146	48	30
2	153	57	30
3	136	63	31

POTENZA WATT	MISURE MM	VARIANTE	CODICE	EAN	IMBALLO	€ IVA ESCLUSA	
38	1	-	LD3PAND38	8031453022792	1/10	26,50	
40	1	-	LD3PAND40	8031453025274	1/10	SU RICHIESTA / UPON REQUEST	
45	2	-	LD3PAND45	8031453022785	1/10	31,80	
42 MAX	DIMMABLE	3	1-10V	LD3PAND42D	8031453021801	1/10	32,44

BTL CATEGORIA SCONTO 23

KIT MONTAGGIO A SOSPENSIONE

SUSPENDED MOUNTING KIT



CODICE	EAN	IMBALLO	€ IVA ESCLUSA
LD3PANCAB	8031453021795	1	9,22

Cavo lungo / cable length: 800 mm

BTL CATEGORIA SCONTO 23

KIT MONTAGGIO A SOSPENSIONE

SUSPENDED MOUNTING KIT



CODICE	EAN	IMBALLO	€ IVA ESCLUSA
LD4PANCAB	8031453022563	1	11,66

Cavo lungo / cable length: 1500 mm

BTL CATEGORIA SCONTO 23

KIT UNIVERSALE MONTAGGIO A PLAFONE

ASSEMBLAGGIO CON VITI

UNIVERSAL CEILING MOUNTING KIT

ASSEMBLY WITH SCREWS



CODICE	MISURE MM	EAN	IMBALLO	€ IVA ESCLUSA
LD2PANFRM-2	600X600	8031453017682	1	31,69
LD2PANFRM-2B	300X1200	8031453017705	1	31,69

BTL CATEGORIA SCONTO 23

KIT UNIVERSALE MONTAGGIO A PLAFONE

ASSEMBLAGGIO AD INCASTRO

UNIVERSAL CEILING MOUNTING KIT

INTERLOCKING ASSEMBLY



CODICE	MISURE MM	EAN	IMBALLO	€ IVA ESCLUSA
LD4PANFRM	600X600	8031453022570	1	20,56
LD4PANFRMB	300X1200	8031453022587	1	24,80

BTL CATEGORIA SCONTO 23

KIT MONTAGGIO AD INCASSO

CON MOLLE

RECESS MOUNTING KIT

WITH SPRINGS



CODICE	EAN	IMBALLO	€ IVA ESCLUSA
LD3PANSPG	8031453021818	1	5,62

BTL CATEGORIA SCONTO 23

KIT UNIVERSALE MONTAGGIO AD INCASSO

CON CORNICE

UNIVERSAL RECESSED MOUNTING KIT

WITH FRAME



CODICE	MISURE MM	EAN	IMBALLO	€ IVA ESCLUSA
LD3PANINK	600X600	8031453022921	1	53,00
LD3PANINKB	300X1200	8031453022938	1	58,30

	LD3PAN3851 LD3PAN3852 LD3PAN3853	LD3PAN3853U	LD3PAN3852U9 LD3PAN3853U9	LD3PAN3853B LD3PAN3853UB	LD3PAN3853UB9	LD3PAN4552U LD3PAN4553U	LD4PAN3652 LD4PAN3653 LD4PAN3653U
DRIVERS RICAMBIO	LD3PAND38	X	X	X	X		
	LD3PAND40					X	
	LD3PAND45					X	
DRIVERS DIM	LD3PAND42D	X	X	X	X	X	
	MFD-1100-42-D	X	X	X	X	X	X
KIT SOSPENSIONE	LD3PANCAB	X	X	X	X	X	
	LD4PANCAB						X
KIT PLAFONE	LD2PANFRM-2	X	X	X		X	X
	LD2PANFRM-2B				X	X	
	LD4PANFRM	X	X	X		X	X
	LD4PANFRMB				X	X	
KIT INCASSO	LD3PANSPG	X	X	X	X	X	
	LD3PANIMK	X	X	X		X	X
	LD3PANIMKB				X	X	

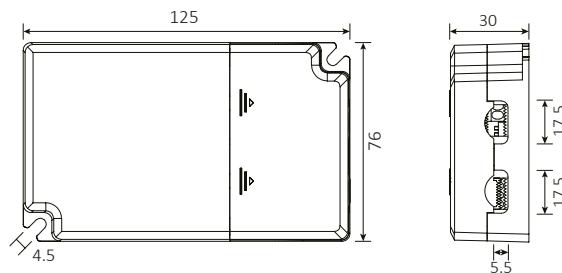
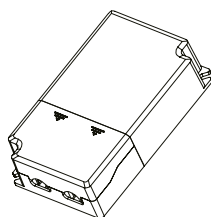
DRIVER DALI / PUSH / 0-10V
 MULTIFUNZIONE
 MULTIFUNCTION

POTENZA WATT	VARIANTE	CODICE	EAN	IMBALLO	€ IVA ESCLUSA
25 MAX	DIMMABLE	DALI/PUSH/0-10V	MFD-600-42-D	8031453023003	1/10 63,60
45 MAX	DIMMABLE	DALI/PUSH/0-10V	MFD-1100-42-D	8031453023010	1/10 66,78

IT

- DRIVER a corrente costante utilizzabile con apparecchi LED dotati di alimentatore esterno (es LED panel o Downlights)
- DIMMERABILE Multifunzione con comando DALI 2 (IEC 62386-101-102-207), PUSH DIM, 0-10V, 10V PWM
- Flicker-free < 3%
- Corrente di output selezionabile mediante dip-switch
- Marchio ENEC
- Isolamento Classe II, SELV secondo EN 61347
- Vita nominale 50.000 ore
- Range di dimmerazione:
DALI 1%-100%
Push-DIM 2%-100%
0-10V: 10%-100%
- Fattore di potenza > 0.95 a piena potenza

MFD-600-42-D (standard 250 mA)

DIP S.W.	1	2	3	4	5
250mA	-	-	-	-	-
300mA	ON	-	-	-	-
350mA	-	ON	-	-	-
400mA	ON	ON	-	-	-
450mA	-	-	ON	-	-
500mA	ON	-	ON	-	-
550mA	-	ON	ON	-	-
600mA	ON	ON	ON	-	-

EN

- Constant current DRIVER usable with LED luminaires equipped with external power supply (e.g. LED panel or Downlights)
- DIMMABLE Multifunction with DALI 2 control (IEC 62386-101-102-207), PUSH DIM, 0-10V, 10V PWM
- Flicker percentage <3%
- Output current selectable by dip-switch
- ENEC brand
- Class II insulation, SELV according to EN 61347
- Nominal life 50,000 hours
- Dimming range:
DALI 1% -100%
Push-DIM 2% -100%
0-10V: 10% -100%
- Power factor > 0.95 at full power

MFD-1100-42-D (standard 650 mA)

DIP S.W.	1	2	3	4	5
650mA	-	-	-	-	-
700mA	ON	-	-	-	-
750mA	-	ON	-	-	-
800mA	-	-	ON	-	-
850mA	ON	-	ON	-	-
900mA	-	ON	ON	-	-
950mA	-	-	ON	ON	-
1000mA	ON	-	ON	ON	-
1050mA	-	ON	ON	ON	-
1100mA	ON	ON	ON	ON	-

0-10V 10V PWM

DALI SETTINGS

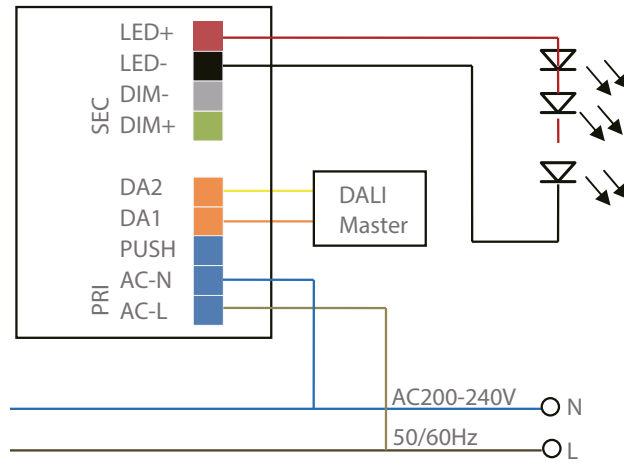

0-10V / 10V PWM

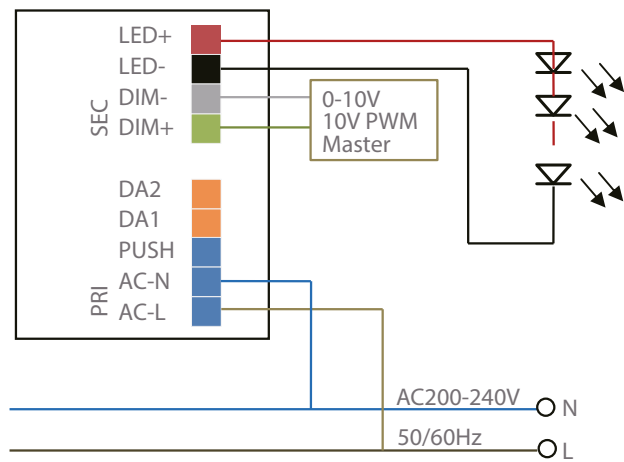

PUSH

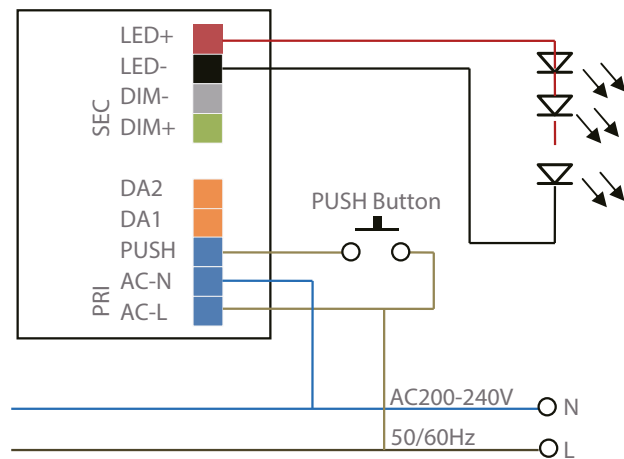

KIT EMERGENZA MULTIFUNZIONE
MULTIFUNCTIONAL EMERGENCY KIT

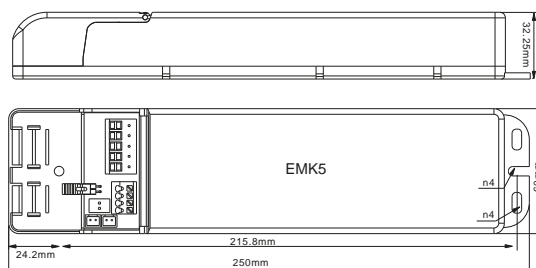

IT

- Uscita DC a potenza costante selezionabile dall'utente tramite dip-switch
- Corrente in uscita regolata automaticamente
- Voltaggio in uscita 10-90V
- Durata 3h con potenza 2,5W e 1,5h con potenza 5,0W
- Batteria integrata LiFePO 6,4V 1500mAh
- Fornito con connettori DC per veloce installazione su pannelli LED ed altri dispositivi che ne sono dotati.

EN

- DC outlet with constant power selectable by the user through DIP switch
- Automatically adjusted output current
- Output voltage 10-90V
- Duration 3h with 2.5W power output and 1.5h with 5.0W power output
- Built-in battery LiFePO 6.4V 1500mAh
- Supplied with DC connectors for quick installation on LED panels and other devices fitted with them.

POTENZA WATT	BASE	KELVIN	LUMEN LM	FASCIO °	MISURE MM	VARIANTE	CODICE	EAN	IMBALLO	€ IVA ESCLUSA
-	-	-	-	-	-	-	EMK5-90-15-A	8031453021832	1/40	86,92

COLLEGAMENTO PER CORRENTE DEL DRIVER <4,0A
 CONNECTION FOR DRIVER CURRENT <4.0A

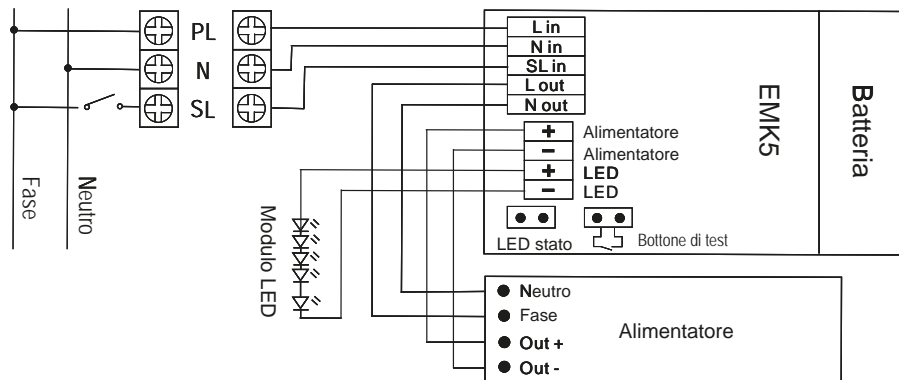

COLLEGAMENTO PER CORRENTE DEL DRIVER >4,0A
 CONNECTION FOR DRIVER CURRENT > 4.0A

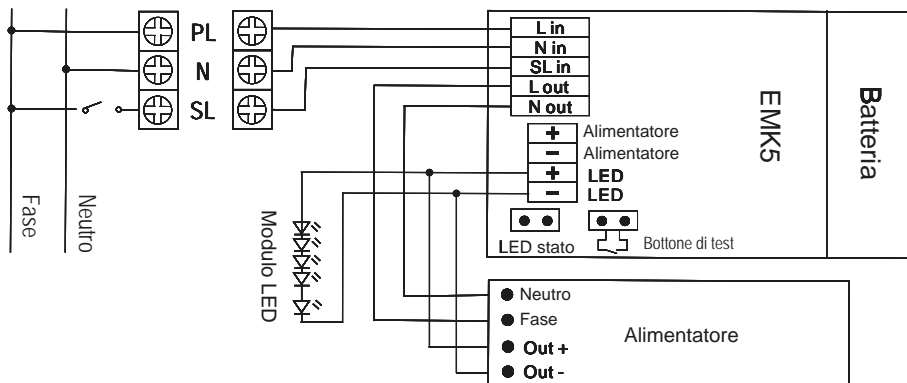

ARTICOLO	DESCRIZIONE	POTENZA NOMINALE (W)	LUMEN NOMINALI	LUMEN EMERGENZA 2,5W	LUMEN EMERGENZA 5W
LD4DWL2452AD	DOWNLIGHT PRO Ø 170MM	24	2550	316	595
LD4DWL2452BD	DOWNLIGHT PRO Ø 220MM	24	2400	327	616
LD3PAN3852	PANNELLO 600X600	38	3800	294	548
LD3PAN3853U	PANNELLO 600X600 UGR<19	38	3800	290	545

LD3PAN3853

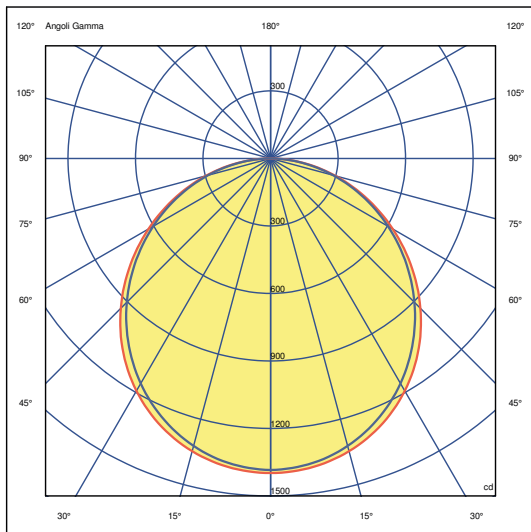

LD3PAN3853B

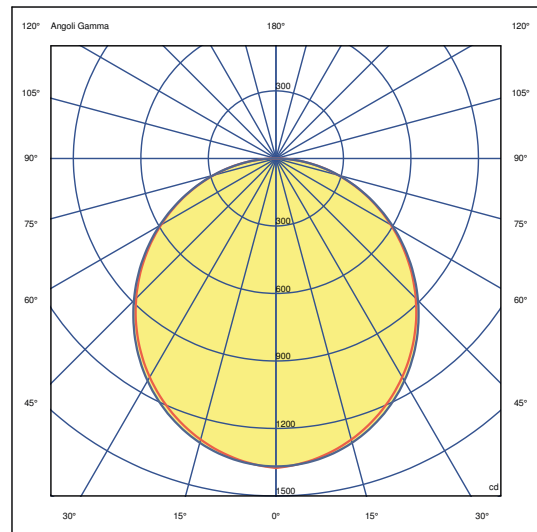

LD3PAN3853U

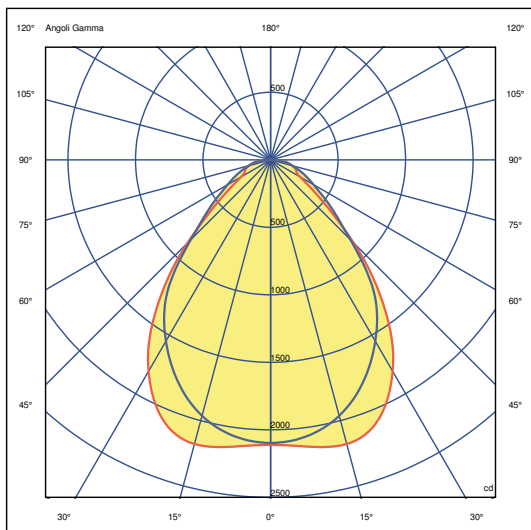

LD3PAN3853UB

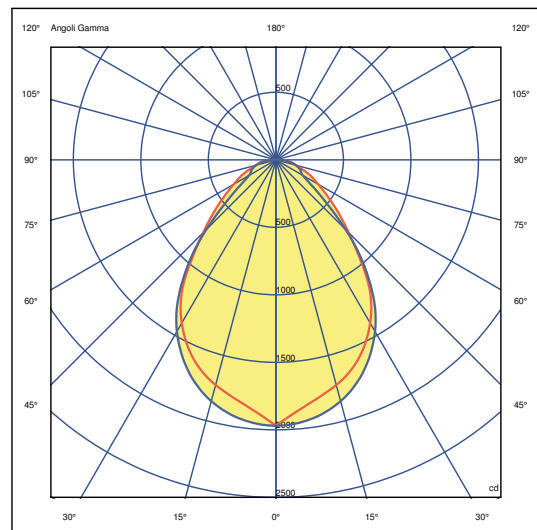

LD3PAN4553U

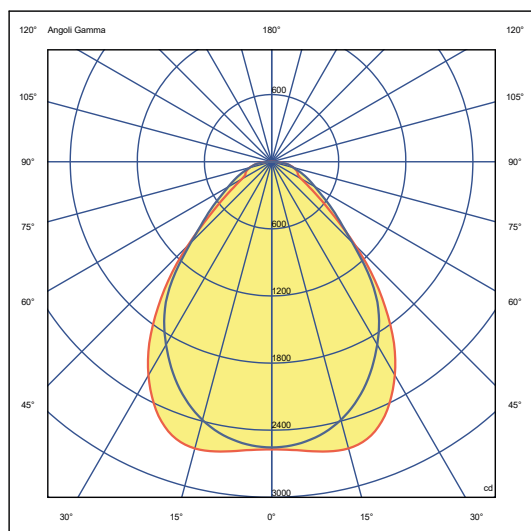

LD4PAN3653

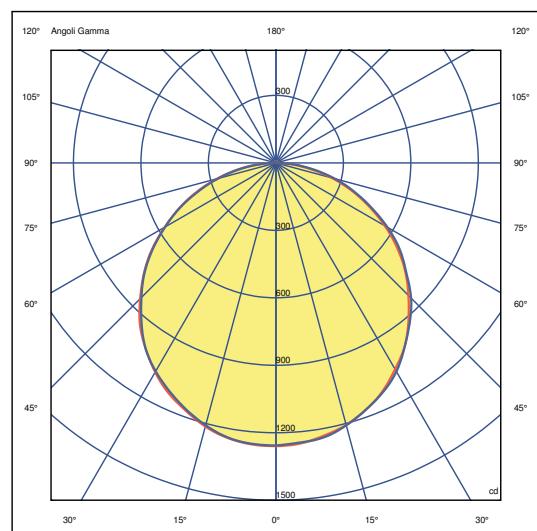

DOWNLIGHT CIO
DIMMERABILE
DIMMABLE

BTL CATEGORIA SCONTO 23

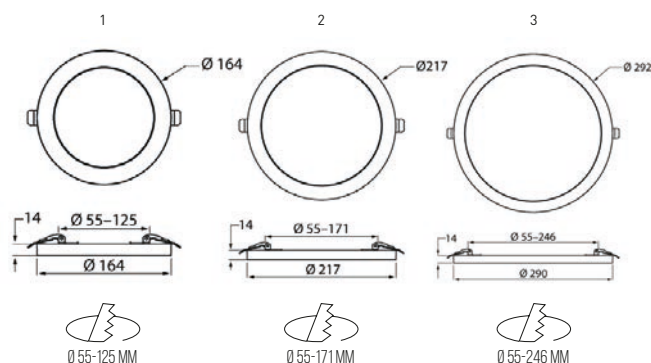

IT

- Pannello ad illuminazione laterale con driver integrato nella cornice, spessore totale 14mm
- Montaggio a superficie con staffa a sgancio rapido
- Montaggio ad incasso con staffa regolabile per foro Ø55-246mm (a seconda del modello)
- Dimmerabile (TRIAC)

EN

- Panel with side light source and driver incorporated in the frame, total thickness 14mm
- Surface mounted with quick release mounting bracket
- Recessed with adjustable mounting bracket for Ø55-246mm hole (depending on model)
- Dimmable (TRIAC)



POTENZA WATT	BASE	KELVIN	LUMEN LM	FASCIO °	MISURE MM	VARIANTE	CODICE	EAN	IMBALLO	€ IVA ESCLUSA
9	-	3000	500	100	1	-	4126217	6435200237569	1	26,50
9	-	4000	500	100	1	-	4126259	6435200242006	1	26,50
12	-	3000	1000	100	2	-	4126218	6435200237576	1	38,16
12	-	4000	1000	100	2	-	4126260	6435200242013	1	38,16
16	-	3000	1500	100	3	-	4126219	6435200237583	1	49,82
16	-	4000	1500	100	3	-	4126261	6435200242020	1	49,82

DOWNLIGHT OSLO ROUND
CON CORNICE INTERCAMBIABILE
WITH INTERCHANGEABLE FRAME

BTL CATEGORIA SCONTO 23

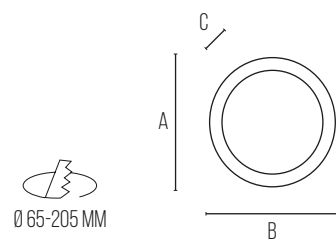

DIMENSIONI	A	B	C
1	220	220	18

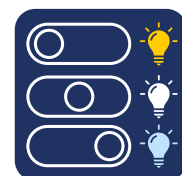

CCT Selezionabile /
selectable CCT:
3000K, 4000K,
6500K

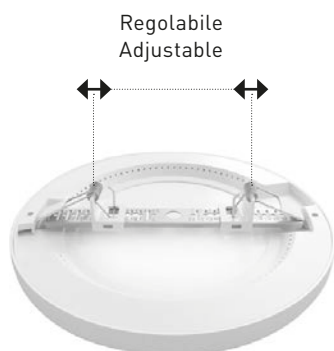

IT

- Pannello ad illuminazione laterale con driver integrato nella cornice, spessore totale 18mm
- Temperatura di colore impostabile mediante selettore
- Cornice bianca in dotazione, opzionale cornice in colore argento, nero, oro rosa
- Montaggio a superficie diretto, o con staffa a sgancio rapido
- Montaggio ad incasso con staffa regolabile per foro Ø65-205mm

EN

- Panel with side light source and driver incorporated in the frame, total thickness 18mm
- Colour temperature can be set by selector switch
- Supplied with white frame, optional frame in silver, black, pink gold colour
- Direct surface mounted or with quick release mounting bracket
- Recessed with adjustable mounting bracket for Ø65-205mm hole

IP20

**220v
240v**

30.000 H

INSTANT

CLASS II

-20° +40°

NOT DIMMABLE

POTENZA WATT	BASE	KELVIN	LUMEN LM	FASCIO °	MISURE MM	VARIANTE	CODICE	EAN	IMBALLO	€ IVA ESCLUSA
18,0	-	3000 4000 6500	1600	110	1	-	OSLO185XC	8031453022334	1/20	42,40
-	-	-	-	-	1	ARGENTO / SILVER	OSL001A	8031453022273	1	7,31
-	-	-	-	-	1	NERO / BLACK	OSL001N	8031453022280	1	7,31
-	-	-	-	-	1	ORO ROSA / PINK GOLD	OSL001R	8031453022297	1	7,31

DOWNLIGHT BIG OSLO ROUND
CON CORNICE INTERCAMBIABILE
WITH INTERCHANGEABLE FRAME

NEW

BTL CATEGORIA SCONTO 23

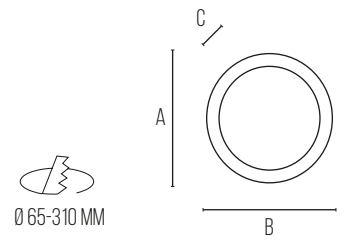

DIMENSIONI	A	B	C
1	330	330	25



CCT Selezionabile /
selectable CCT:
3000K, 4000K,
5700K



IT

- Pannello ad illuminazione laterale con driver integrato nella cornice, spessore totale 25mm
- Temperatura di colore impostabile mediante selettore
- Cornice bianca in dotazione, opzionale cornice in colore argento, nero, oro rosa
- Montaggio a superficie diretto, o con staffa a sgancio rapido
- Montaggio ad incasso con staffa regolabile per foro Ø65-310mm

EN

- Panel with side light source and driver incorporated in the frame, total thickness 25mm
- Colour temperature can be set by selector switch
- Supplied with white frame, optional frame in silver, black, pink gold colour
- Direct surface mounted or with quick release mounting bracket
- Recessed with adjustable mounting bracket for Ø65-310mm hole

IP20

220v
240v

30.000 H

INSTANT

CLASS II

-20° **+40°**

NOT DIMMABLE

POTENZA WATT	BASE	KELVIN	LUMEN LM	FASCIO °	MISURE MM	VARIANTE	CODICE	EAN	IMBALLO	€ IVA ESCLUSA
28,0	-	3000 4000 5700	2500	110	1	-	OSLO285XC	8031453025236	1/10	86,77
-	-	-	-	-	1	ARGENTO / SILVER	OSLO11A	8031453025243	1	11,97
-	-	-	-	-	1	NERO / BLACK	OSLO11N	8031453025250	1	11,97
-	-	-	-	-	1	ORO ROSA / PINK GOLD	OSLO11R	8031453025267	1	11,97

DOWNLIGHT OSLO SQUARED
CON CORNICE INTERCAMBIABILE
WITH INTERCHANGEABLE FRAME

BTL CATEGORIA SCONTO 23

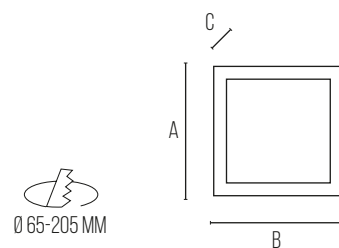

DIMENSIONI	A	B	C
1	220	220	18

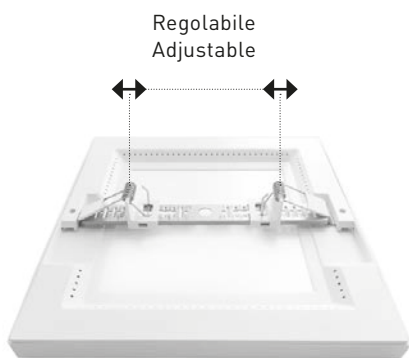

CCT Selezionabile /
selectable CCT:
3000K, 4000K,
6500K

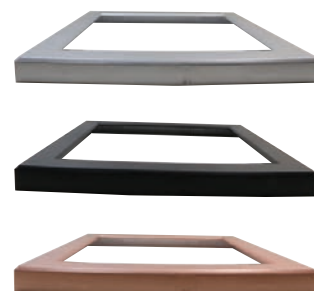

IT

- Pannello ad illuminazione laterale con driver integrato nella cornice, spessore totale 18mm
- Temperatura di colore impostabile mediante selettore
- Cornice bianca in dotazione, opzionale cornice in colore argento, nero, oro rosa
- Montaggio a superficie diretto, o con staffa a sgancio rapido
- Montaggio ad incasso con staffa regolabile per foro Ø65-205mm

EN

- Panel with side light source and driver incorporated in the frame, total thickness 18mm
- Colour temperature can be set by selector switch
- Supplied with white frame, optional frame in silver, black, pink gold colour
- Direct surface mounted or with quick release mounting bracket
- Recessed with adjustable mounting bracket for Ø65-205mm hole

POTENZA WATT	BASE	KELVIN	LUMEN LM	FASCIO °	MISURE MM	VARIANTE	CODICE	EAN	IMBALLO	€ IVA ESCLUSA
18,0	-	3000 4000 6500	1600	110	1	-	OSLO185XQ	8031453022341	1/20	44,52
-	-	-	-	-	1	ARGENTO / SILVER	OSL002A	8031453022303	1	9,12
-	-	-	-	-	1	NERO / BLACK	OSL002N	8031453022310	1	9,12
-	-	-	-	-	1	ORO ROSA / PINK GOLD	OSL002R	8031453022327	1	9,12

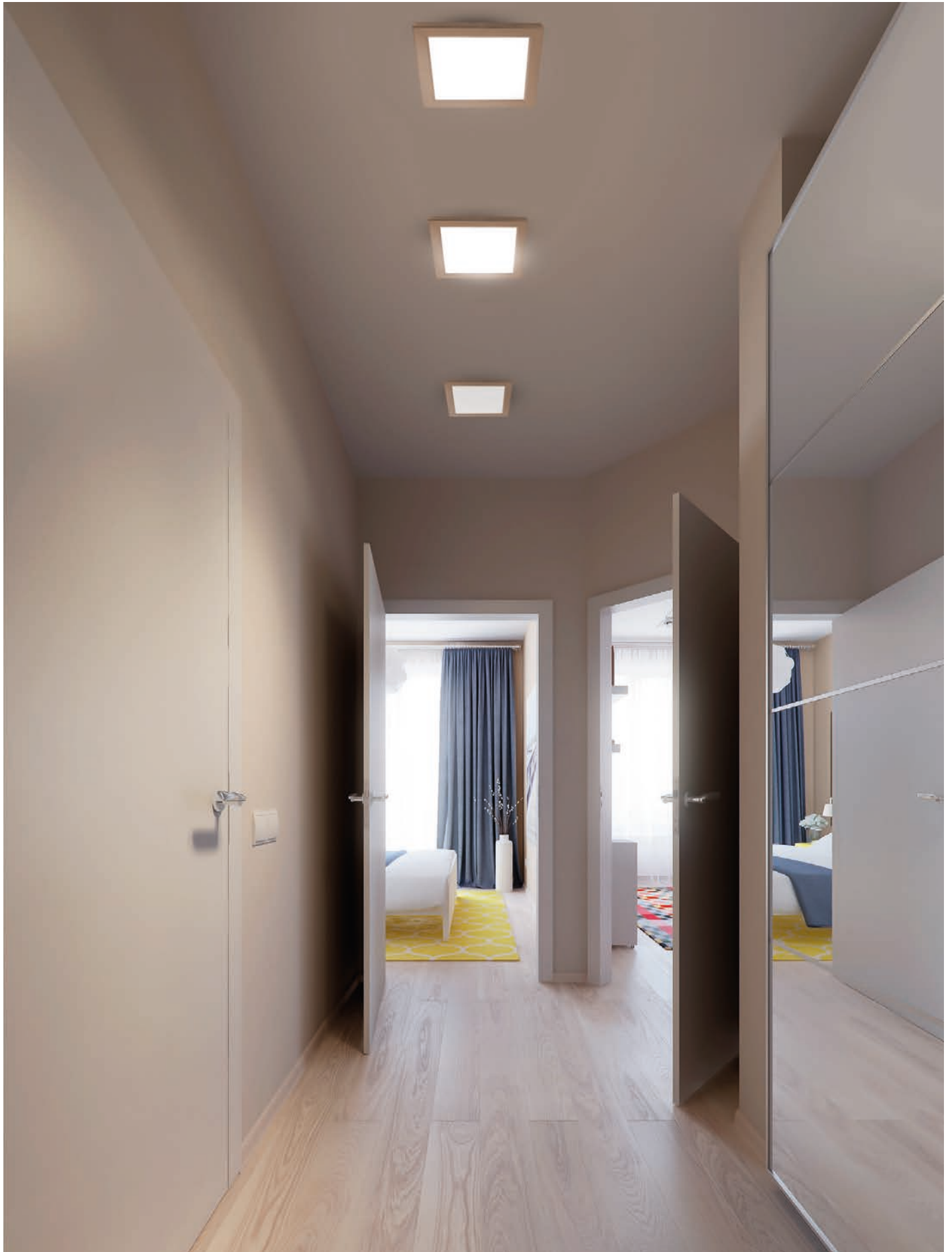

DOWNLIGHT PRO Ø170

DIMMERABILE
DIMMABLE

BTL CATEGORIA SCONTO 23

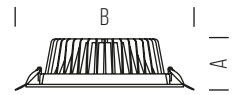

DIMENSIONI	A	B
1	58	170

170 42
30
Driver compreso
nella confezione



IT

- Corpo in alluminio pressofuso per una maggiore dissipazione del calore
- Driver esterno flicker-free dimmerabile
- Dimmerabile (TRIAC)
- Protezione IP44 Frontale (IP20 posteriore ed alimentatore)

EN

- Die-cast aluminium body for greater heat dissipation
- External dimmable flicker-free driver
- Dimmable (TRIAC)
- IP44 front protection rating (IP20 rear and driver)

IP44

220v
240v

50.000 H

INSTANT

CLASS II

-20° **+40°**

DIMMABLE

POTENZA WATT	BASE	KELVIN	LUMEN LM	FASCIO °	MISURE MM	VARIANTE	CODICE	EAN	IMBALLO	€ IVA ESCLUSA
24	-	3000	2550	100	1	-	LD4DWL2452AD	8031453019433	1/10	54,06
24	-	4000	2550	100	1	-	LD4DWL2453AD	8031453019457	1/10	54,06

DOWNLIGHT PRO Ø220

DIMMERABILE
 DIMMABLE

BTL CATEGORIA SCONTO 23

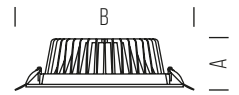

DIMENSIONI	A	B
1	69	220

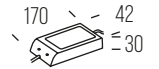

Driver compreso
 nella confezione



IT

- Corpo in alluminio pressofuso per una maggiore dissipazione del calore
- Driver esterno flicker-free dimmerabile
- Dimmerabile (TRIAC)
- Protezione IP44 Frontale (IP20 posteriore ed alimentatore)

EN

- Die-cast aluminium body for greater heat dissipation
- External dimmable flicker-free driver
- Dimmable (TRIAC)
- IP44 front protection rating (IP20 rear and driver)



POTENZA WATT	BASE	KELVIN	LUMEN LM	FASCIO °	MISURE MM	VARIANTE	CODICE	EAN	IMBALLO	€ IVA ESCLUSA
24	-	3000	2400	100	1	-	LD4DWL2452BD	8031453019440	1/10	62,54
24	-	4000	2400	100	1	-	LD4DWL2453BD	8031453019464	1/10	62,54

DOWNLIGHT SLIM PRO

BTL CATEGORIA SCONTO 23

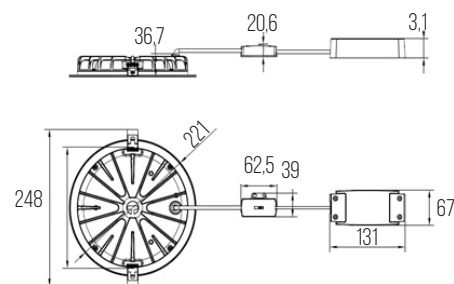

CCT Selezionabile /
selectable CCT:
3000K, 4000K,
6500K

IT

- Corpo in alluminio pressofuso per una maggiore dissipazione del calore
- Spessore ridotto di soli 38mm
- Temperatura di colore impostabile mediante selettore
- Protezione IP54 Frontale (IP20 posteriore ed alimentatore)

EN

- Die-cast aluminium body for greater heat dissipation
- Reduced thickness, only 38mm
- Colour temperature can be set by selector switch
- IP54 front protection rating (IP20 rear and driver)



POTENZA WATT	BASE	KELVIN	LUMEN LM	FASCIO °	MISURE MM	VARIANTE	CODICE	EAN	IMBALLO	€ IVA ESCLUSA
28	-	3000 4000 6500	3100	100	1	-	LD5DWL285CCTB	8031453022976	1/5	72,08

MODIGLIANI

MODULO LED CRI>90 DIMMERABILE
DIMMABLE LED MODULE CRI> 90

BTL CATEGORIA SCONTO 23

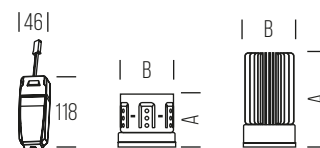

DIMENSIONI	A	B
1	51	50
2	87	50



IT

- Moduli led 50mm di diametro
- Fascio 24° - 38° - 60°
- Driver dimmerabile incluso nella confezione con connettore a sgancio rapido
- Alta resa dei colori (CRI>90)

EN

- LED modules with 50 mm diameter
- Beam 24° - 38° - 60°
- Dimmable driver included in the kit with quick-release connector
- High colour rendering (CRI>90)

IP20

220v
240v

30.000 H

INSTANT

CLASS II

-20° +40°

CRI>90

DIMMABLE

POTENZA WATT	BASE	KELVIN	LUMEN LM	FASCIO °	MISURE MM	VARIANTE	CODICE	EAN	IMBALLO	€ IVA ESCLUSA
8,5	-	3000	600	24	1	-	LD1SPT0922	8031453005016	1/20	38,05
8,5	-	3000	600	38	1	-	LD1SPT0923	8031453005030	1/20	38,05
8,5	-	3000	600	60	1	-	LD1SPT0924	8031453005054	1/20	38,05
12,5	-	3000	1000	38	2	-	LD1SPT1332	8031453006341	1/20	42,29
12,5	-	3000	1000	60	2	-	LD1SPT1342	8031453006365	1/20	42,29

LD4DWL2453BD

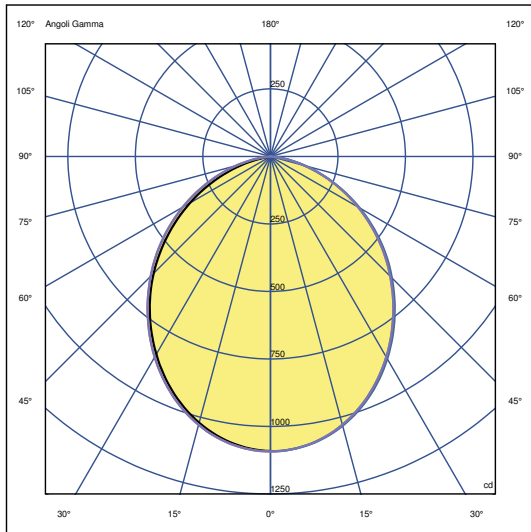

LD1SPT0922

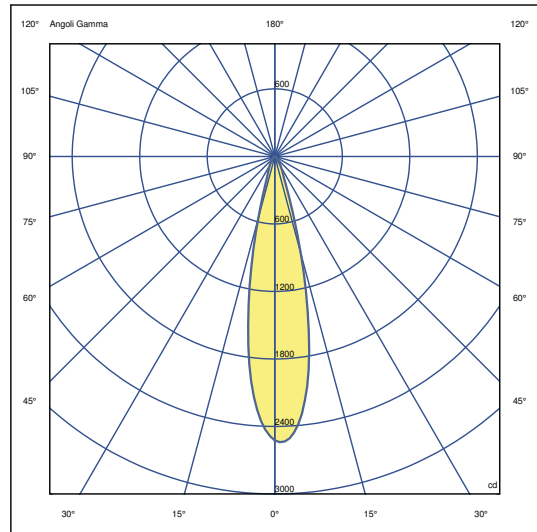

LD1SPT0923

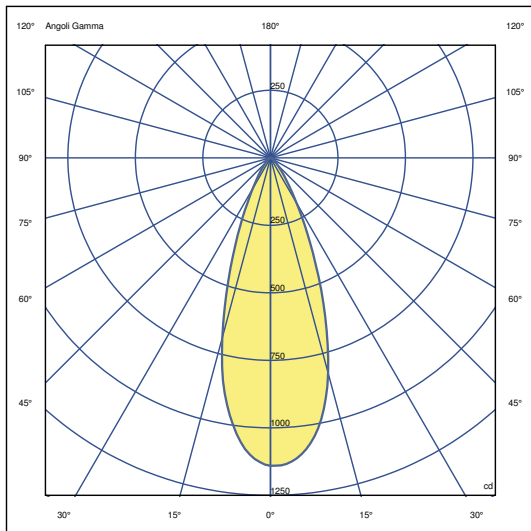

LD1SPT0924

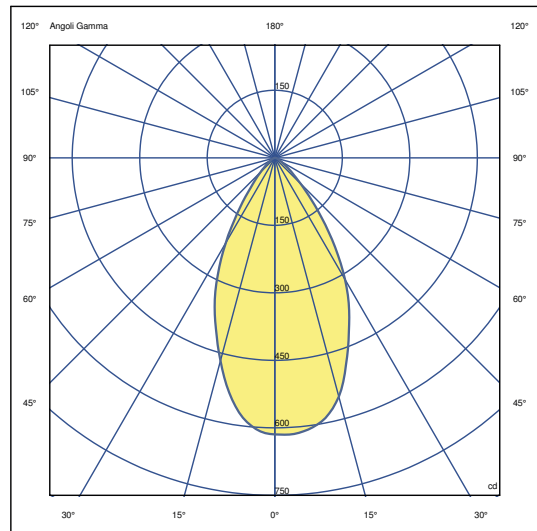

LD1SPT1332

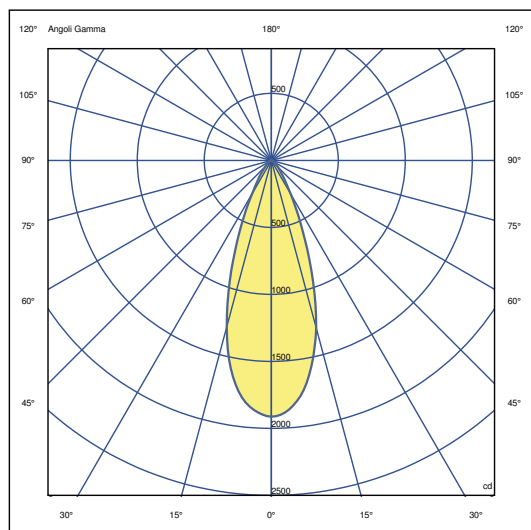

LD1SPT1342

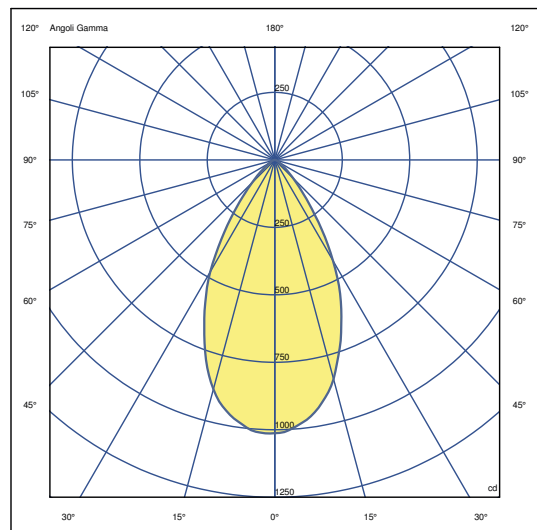

ANELLI DI FISSAGGIO ORIENTABILI
ADJUSTABLE FIXING RINGS

BTL CATEGORIA SCONTO 23

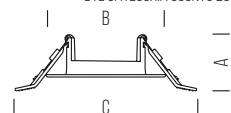

DIMENSIONI	A	B	C
1	27	84	142

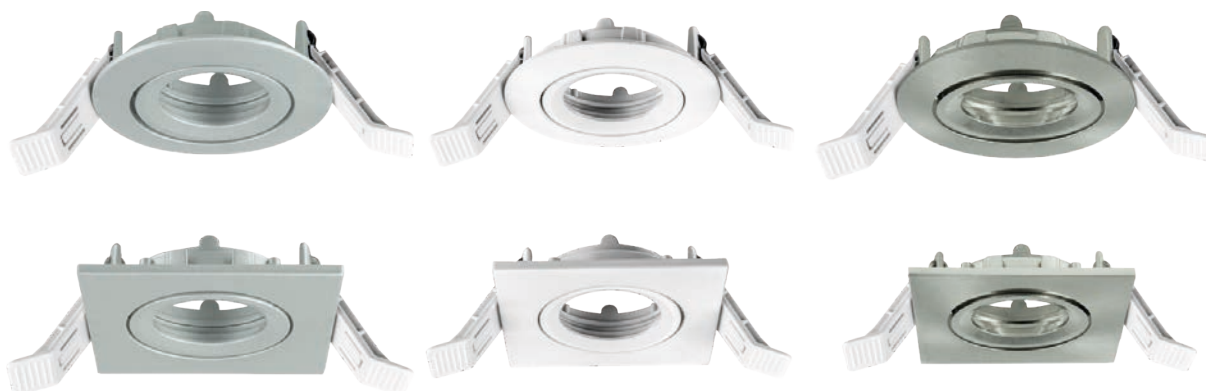

IT

- Faretto per montaggio ad incasso, realizzato in fusione di alluminio
- Alloggia lampade alogene e LED diametro 50mm con base GU10 - G5.3 (portalampada non fornito)
- Alloggia modulo LED diametro 50mm 'MODIGLIANI'

EN

- Recessed spotlight, made from die-cast aluminium
- Requires halogen and LED lamps diameter 50mm with base GU10 - G5.3 (lampholder not supplied)
- Can fit 50 mm diameter LED module 'MODIGLIANI'

COLORE	FORMA	DIAMETRO FORO MM	MISURE MM	CODICE	EAN	IMBALLO	€ IVA ESCLUSA
ARGENTO / SILVER	CIRCOLARE	75-80	1	LD2SPTA01A	8031453020712	1/100	7,74
BIANCO / WHITE	CIRCOLARE	75-80	1	LD2SPTA01B	8031453020729	1/100	5,41
SPAZZOLATO / BRUSHED	CIRCOLARE	75-80	1	LD2SPTA01S	8031453020736	1/100	6,78
ARGENTO / SILVER	QUADRATO	75-80	1	LD2SPTA02A	8031453020743	1/100	8,27
BIANCO / WHITE	QUADRATO	75-80	1	LD2SPTA02B	8031453020750	1/100	5,83
SPAZZOLATO / BRUSHED	QUADRATO	75-80	1	LD2SPTA02S	8031453020767	1/100	8,27

ANELLO DI FISSAGGIO FISSO PER AMBIENTI UMIDI CON VETRO FRONTALE IP65

FIXED FIXING RING FOR HUMID ENVIRONMENTS WITH FRONT IP65 GLASS

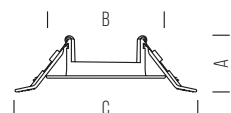

DIMENSIONI	A	B	C
1	32	90	137



COLORE	FORMA	DIAMETRO FORO MM	MISURE MM	CODICE	EAN	IMBALLO	€ IVA ESCLUSA
BIANCO / WHITE	CIRCOLARE	65-80	1	LD1SPTA91B	8031453005252	1/20	9,43

CENTER

PROIETTORE DA BINARIO TRACKLIGHT

BTL CATEGORIA SCONTO 23

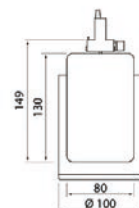
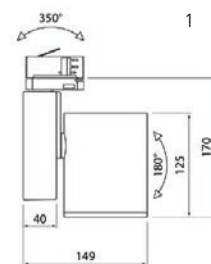

IT

- Proiettore per binario ad alta potenza
- Spotlight per utilizzo in negozi e spazi pubblici
- Disponibili in 2 temperature di colore e 3 fasci (17°-25°-40°)
- Corpo in alluminio verniciato
- Adattatore Global Trac trifase

EN

- High power track light
- Spotlight for use in stores and public spaces
- Available in 2 colour temperatures and 3 beams (17°-25°-40°)
- Made from painted aluminium
- Global Trac three-phase adapter

IP20

 220v
240v

50.000 H
INSTANT
CRI>90
0° **+35°**
NOT DIMMABLE

POTENZA WATT	BASE	KELVIN	LUMEN LM	FASCIO °	MISURE MM	VARIANTE	CODICE	EAN	IMBALLO	€ IVA ESCLUSA
35	-	3000	2500	17	1	BIANCO / WHITE	4209505	6435200232649	1/8	147,34
35	-	3000	2500	25	1	BIANCO / WHITE	4209506	6435200232656	1/8	147,34
35	-	3000	2500	40	1	BIANCO / WHITE	4209507	6435200232663	1/8	147,34
35	-	4000	2700	17	1	BIANCO / WHITE	4209508	6435200232670	1/8	147,34
35	-	4000	2700	25	1	BIANCO / WHITE	4209509	6435200232687	1/8	147,34
35	-	4000	2700	40	1	BIANCO / WHITE	4209510	6435200232694	1/8	147,34
35	-	3000	2500	17	1	NERO / BLACK	4209511	6435200232700	1/8	147,34
35	-	3000	2500	25	1	NERO / BLACK	4209512	6435200232717	1/8	147,34
35	-	3000	2500	40	1	NERO / BLACK	4209513	6435200232724	1/8	147,34
35	-	4000	2700	17	1	NERO / BLACK	4209514	6435200232731	1/8	147,34
35	-	4000	2700	25	1	NERO / BLACK	4209515	6435200232748	1/8	147,34
35	-	4000	2700	40	1	NERO / BLACK	4209516	6435200232755	1/8	147,34

Articoli solo su ordinazione / Items made to order only

CENTER
PROIETTORE DA BINARIO
TRACKLIGHT

BTL CATEGORIA SCONTO 23

1

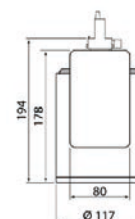
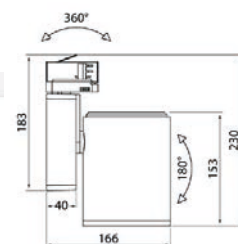

IT

- Proiettore per binario ad alta potenza
- Spotlight per utilizzo in negozi e spazi pubblici
- Disponibili in 2 temperature di colore e 3 fasci (17°-25°-40°)
- Corpo in alluminio verniciato
- Adattatore Global Trac trifase

EN

- High power track light
- Spotlight for use in stores and public spaces
- Available in 2 colour temperatures and 3 beams (17°-25°-40°)
- Made from painted aluminium
- Global Trac three-phase adapter



50.000 H



CRI > 90



POTENZA WATT	BASE	KELVIN	LUMEN LM	FASCIO °	MISURE MM	VARIANTE	CODICE	EAN	IMBALLO	€ IVA ESCLUSA
50	-	3000	4300	25	1	BIANCO / WHITE	4209529	6435200233790	1/8	172,78
50	-	3000	4300	40	1	BIANCO / WHITE	4209531	6435200233813	1/8	172,78
50	-	4000	4500	25	1	BIANCO / WHITE	4297895	6435200232540	1/8	172,78
50	-	4000	4500	40	1	BIANCO / WHITE	4209504	6435200232632	1/8	172,78
50	-	3000	4300	25	1	NERO / BLACK	4209530	6435200233806	1/8	172,78
50	-	3000	4300	40	1	NERO / BLACK	4209532	6435200233820	1/8	172,78
50	-	4000	4500	25	1	NERO / BLACK	4209501	6435200232601	1/8	172,78
50	-	4000	4500	40	1	NERO / BLACK	4297898	6435200232571	1/8	172,78

Articoli solo su ordinazione / Items made to order only



CENTER FOOD

PROIETTORE DA BINARIO PER CARNE
TRACKLIGHT FOR MEAT

BTL CATEGORIA SCONTO 23

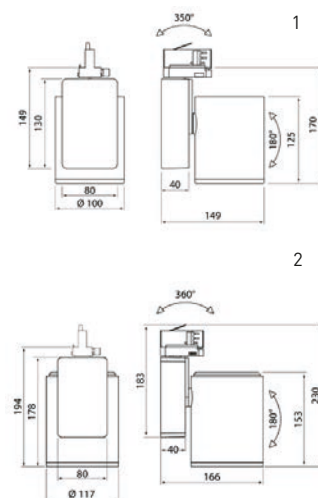

IT

- Proiettore per binario ad alta potenza
- Spotlight per utilizzo in negozi per banco carne
- Corpo in alluminio verniciato
- Adattatore Global Trac trifase

EN

- High power track light
- Spotlight for use in stores for meat counter
- Made from painted aluminium
- Global Trac three-phase adapter

POTENZA WATT	BASE	KELVIN	LUMEN LM	FASCIO °	MISURE MM	VARIANTE	CODICE	EAN	IMBALLO	€ IVA ESCLUSA
35	-	3000	1800	17	1	BIANCO / WHITE	4222700	6435200241054	1/8	167,48
35	-	3000	1800	25	1	BIANCO / WHITE	4222701	6435200241061	1/8	167,48
35	-	3000	1800	40	1	BIANCO / WHITE	4222702	6435200241078	1/8	167,48
50	-	3000	3000	25	2	BIANCO / WHITE	4222712	6435200241177	1/8	192,92
50	-	3000	3000	40	2	BIANCO / WHITE	4222713	6435200241184	1/8	192,92
35	-	3000	1800	17	1	NERO / BLACK	4222703	6435200241085	1/8	167,48
35	-	3000	1800	25	1	NERO / BLACK	4222704	6435200241092	1/8	167,48
35	-	3000	1800	40	1	NERO / BLACK	4222705	6435200241108	1/8	167,48
50	-	3000	3000	25	2	NERO / BLACK	4222714	6435200241191	1/8	192,92
50	-	3000	3000	40	2	NERO / BLACK	4222715	6435200241207	1/8	192,92

Articoli solo su ordinazione / Items made to order only

CENTER FOOD

 PROIETTORE DA BINARIO PER PANE E VEGETALI
 TRACKLIGHT FOR BREAD OR VEGETABLES

BTL CATEGORIA SCONTO 23

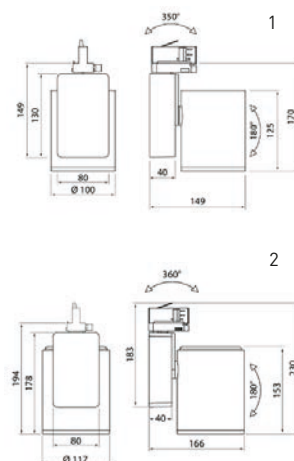
IT

- Proiettore per binario ad alta potenza
- Spotlight per utilizzo in negozi per banco pane e vegetali
- Disponibili in 3 fasci (17°-25°-40°)
- Corpo in alluminio verniciato bianco o nero
- Adattatore Global Trac trifase

EN

- High power track light
- Spotlight for use in stores for bread and vegetables counter
- Available in 3 beams (17°-25°-40°)
- Made from white or black painted aluminium
- Global Trac three-phase adapter

IP20
50.000 H
INSTANT
0° +35°

POTENZA WATT	BASE	KELVIN	LUMEN LM	FASCIO °	MISURE MM	VARIANTE	CODICE	EAN	IMBALLO	€ IVA ESCLUSA
35	-	2500	1800	17	1	BIANCO / WHITE	4222706	6435200241115	1/8	167,48
35	-	2500	1800	25	1	BIANCO / WHITE	4222707	6435200241122	1/8	167,48
35	-	2500	1800	40	1	BIANCO / WHITE	4222708	6435200241139	1/8	167,48
50	-	2500	3000	25	2	BIANCO / WHITE	4222716	6435200241214	1/8	192,92
50	-	2500	3000	40	2	BIANCO / WHITE	4222717	6435200241221	1/8	192,92
35	-	2500	1800	17	1	NERO / BLACK	4222709	6435200241146	1/8	167,48
35	-	2500	1800	25	1	NERO / BLACK	4222710	6435200241153	1/8	167,48
35	-	2500	1800	40	1	NERO / BLACK	4222711	6435200241160	1/8	167,48
50	-	2500	3000	25	2	NERO / BLACK	4222718	6435200241238	1/8	192,92
50	-	2500	3000	40	2	NERO / BLACK	4222719	6435200241245	1/8	192,92

Articoli solo su ordinazione / Items made to order only

4209507-4209513

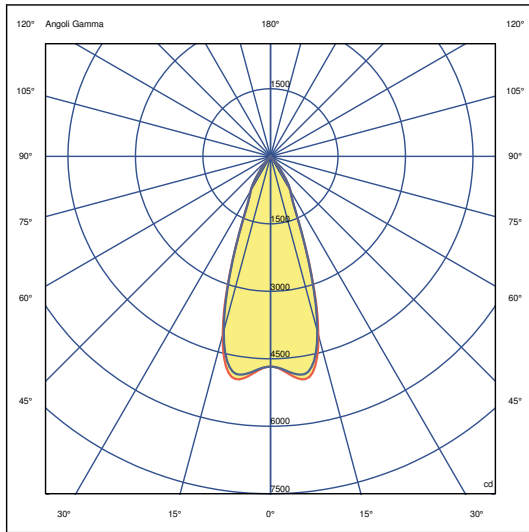

4209508-4209514

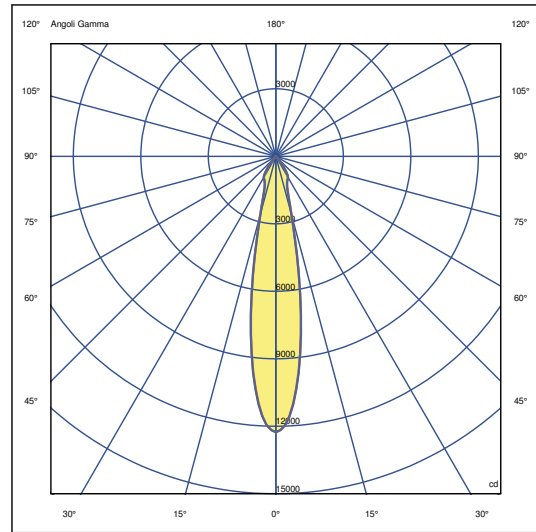

4209509-4209515

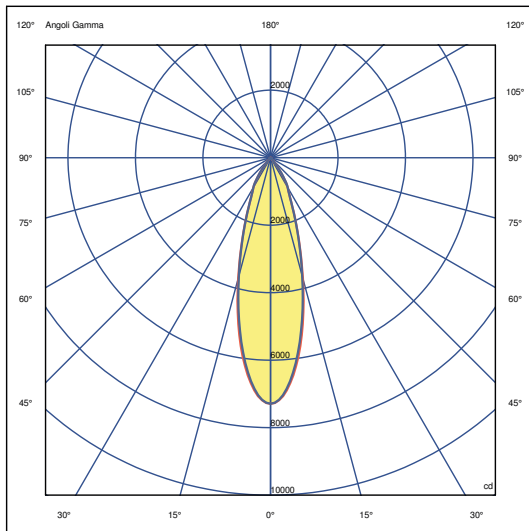

4209510-4209516

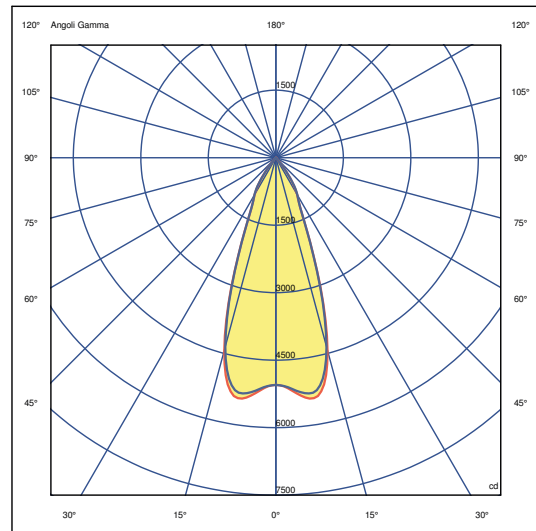

4297895-4209501

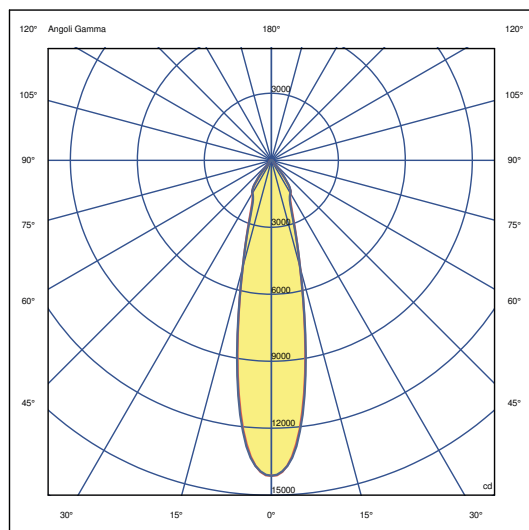

4209504-4297898

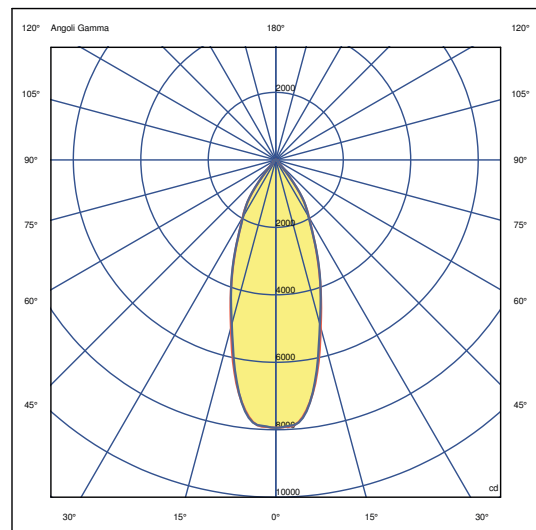

VIENNA CRI>97
PROIETTORE DA BINARIO
TRACKLIGHT

AGGIORNATO

BTL CATEGORIA SCONTO 23

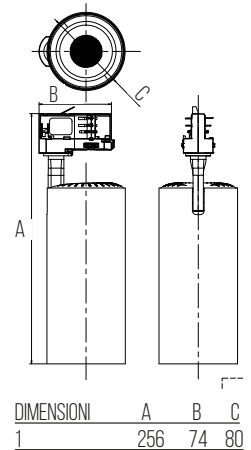

IT

- Proiettore per binario ad alta potenza
- Driver integrato nell'elemento cilindrico
- Corpo in alluminio verniciato bianco o nero
- Adattatore per binario a 3 fasi.
- Disponibili 2 temperature di colore e 3 fasci (24°, 36° e 64°)

EN

- High power track spotlight
- Built-in driver
- White or black aluminium body
- 3-phase track adapter.
- Available in 2 colour temperatures and 3 beam angles (24°, 36° and 64°)

IP20

**220v
240v**

30.000 H

INSTANT

CLASS II

-20° +40°

CRI>97

NOT DIMMABLE

POTENZA WATT	BASE	KELVIN	LUMEN LM	FASCIO °	MISURE MM	VARIANTE	CODICE	EAN	IMBALLO	€ IVA ESCLUSA
30	-	3000	2600	24	1	BIANCO / WHITE	VIENNA3022B	8031453022228	1/10	92,22
30	-	3000	2600	24	1	NERO / BLACK	VIENNA3022N	8031453022235	1/10	92,22
30	-	4000	2700	24	1	BIANCO / WHITE	VIENNA3023B	8031453022242	1/10	92,22
30	-	4000	2700	24	1	NERO / BLACK	VIENNA3023N	8031453022259	1/10	92,22
30	-	3000	2600	36	1	BIANCO / WHITE	VIENNA3032B	8031453022174	1/10	92,22
30	-	3000	2600	36	1	NERO / BLACK	VIENNA3032N	8031453022181	1/10	92,22
30	-	4000	2700	36	1	BIANCO / WHITE	VIENNA3033B	8031453022198	1/10	92,22
30	-	4000	2700	36	1	NERO / BLACK	VIENNA3033N	8031453022204	1/10	92,22
NEW 30	-	3000	2600	64	1	BIANCO / WHITE	VIENNA3052B	8031453024833	1/10	92,22
NEW 30	-	3000	2600	64	1	NERO / BLACK	VIENNA3052N	8031453024840	1/10	92,22
NEW 30	-	4000	2700	64	1	BIANCO / WHITE	VIENNA3053B	8031453024857	1/10	92,22
NEW 30	-	4000	2700	64	1	NERO / BLACK	VIENNA3053N	8031453024864	1/10	92,22

IT

- Lente di ricambio 24° o 64°

EN

- Spare lens 24° or 64°

-	-	-	-	24	1	-	VIENNAL24	8031453022211	1	4,13
NEW	-	-	-	64	1	-	VIENNAL64	8031453024826	1	4,13

VIENNA3022B

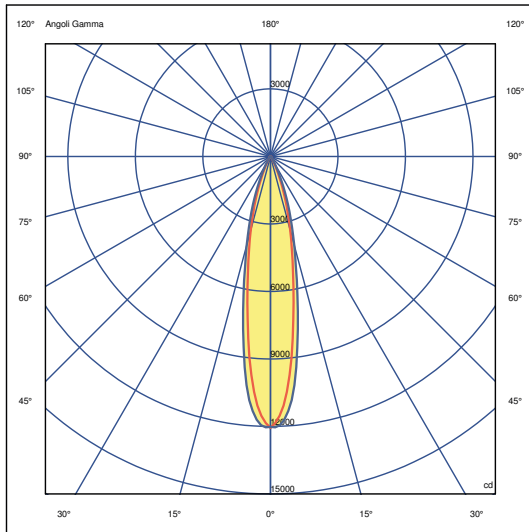

VIENNA3023B

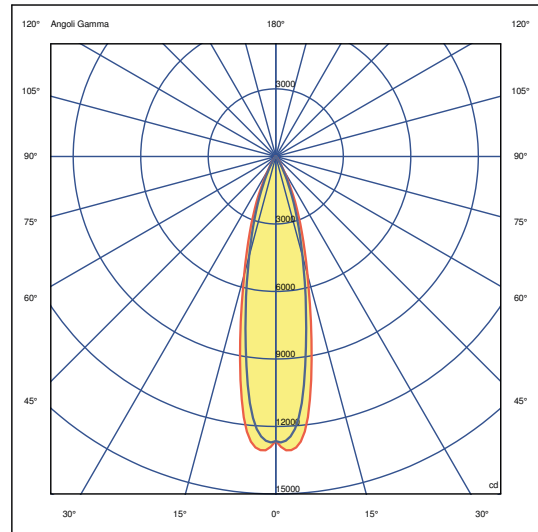

VIENNA3032B

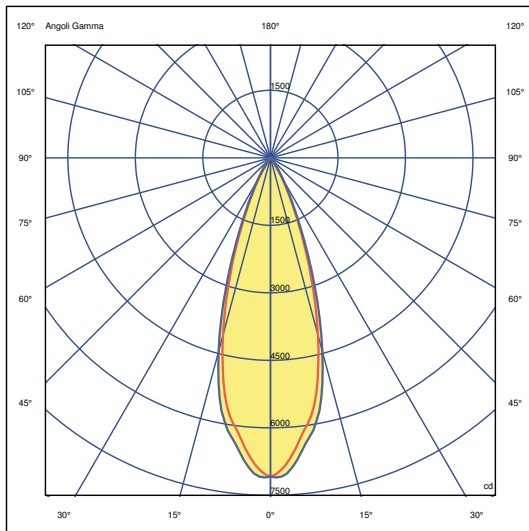

VIENNA3033B

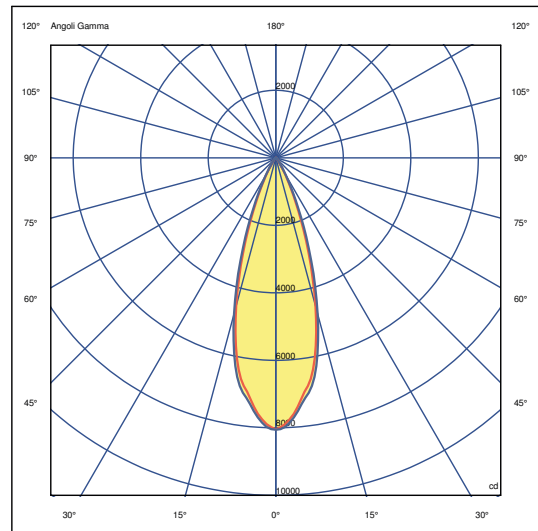

VIENNA3052B

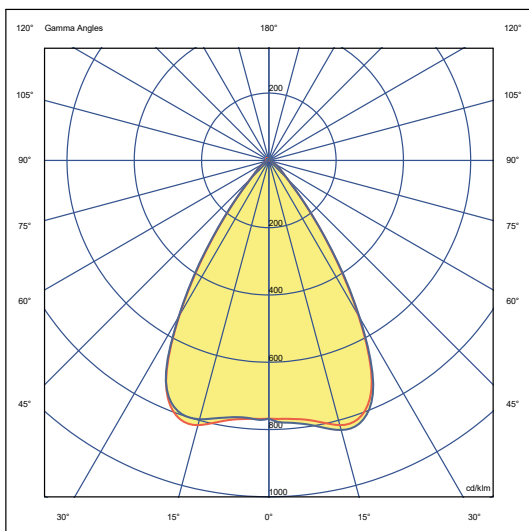

VIENNA3053B

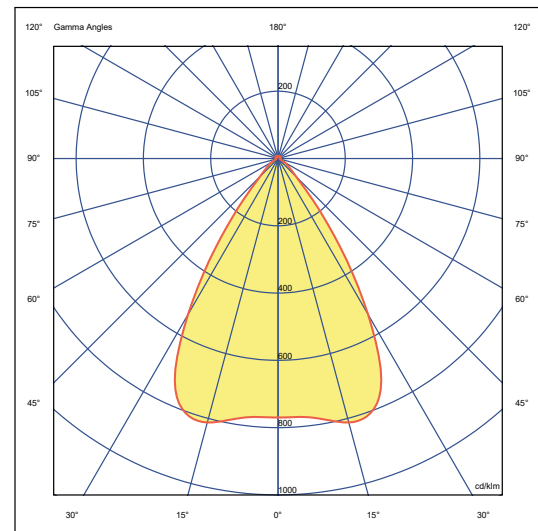

BINARIO 6 CONDUTTORI EUROSTANDARD® PLUS EUROSTANDARD PLUS® 6 CONDUCTORS TRACK

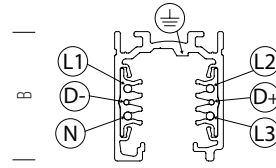
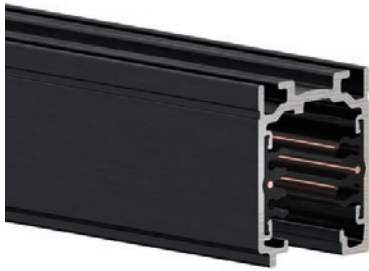

DIMENSIONI	A	B	C
1	1000	37,8	31,4
2	2000	37,8	31,4
3	3000	37,8	31,4
4	4000	37,8	31,4

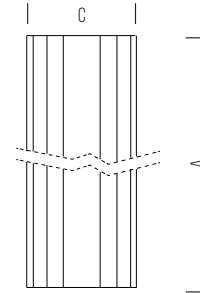

IP20

ARTICOLO	VARIANTE	MATERIALE	MISURE	CODICE	EAN	IMBALLO
BINARIO A 6 CONDUTTORI EUROSTANDARD PLUS METRI 1	NERO / BLACK (RAL 9005)	ALLUMINIO / ALUMINUM	1	9000-1/B-ST	-	1
BINARIO A 6 CONDUTTORI EUROSTANDARD PLUS METRI 1	BIANCO / WHITE (RAL 9010)	ALLUMINIO / ALUMINUM	1	9000-1/W-ST	-	1
BINARIO A 6 CONDUTTORI EUROSTANDARD PLUS METRI 2	NERO / BLACK (RAL 9005)	ALLUMINIO / ALUMINUM	2	9000-2/B-ST	-	1
BINARIO A 6 CONDUTTORI EUROSTANDARD PLUS METRI 2	BIANCO / WHITE (RAL 9010)	ALLUMINIO / ALUMINUM	2	9000-2/W-ST	-	1
BINARIO A 6 CONDUTTORI EUROSTANDARD PLUS METRI 3	NERO / BLACK (RAL 9005)	ALLUMINIO / ALUMINUM	3	9000-3/B-ST	-	1
BINARIO A 6 CONDUTTORI EUROSTANDARD PLUS METRI 3	BIANCO / WHITE (RAL 9010)	ALLUMINIO / ALUMINUM	3	9000-3/W-ST	-	1
BINARIO A 6 CONDUTTORI EUROSTANDARD PLUS METRI 4	NERO / BLACK (RAL 9005)	ALLUMINIO / ALUMINUM	4	9000-4/B-ST	-	1
BINARIO A 6 CONDUTTORI EUROSTANDARD PLUS METRI 4	BIANCO / WHITE (RAL 9010)	ALLUMINIO / ALUMINUM	4	9000-4/W-ST	-	1

Prezzi su richiesta / Prices on request

TAPPO DI CHIUSURA PER BINARIO CON VITE DI BLOCCO END CAP FOR TRACK WITH LOCKING SCREW

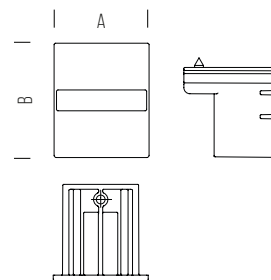

DIMENSIONI	A	B
1	31,4	37,8

IP20

ARTICOLO	VARIANTE	MATERIALE	MISURE	CODICE	EAN	IMBALLO
TAPPO DI CHIUSURA PER BINARIO CON VITE DI BLOCCO	NERO / BLACK (RAL 9005)	POLICARBONATO / POLYCARBONATE	1	9004/B	-	1
TAPPO DI CHIUSURA PER BINARIO CON VITE DI BLOCCO	BIANCO / WHITE (RAL 9010)	POLICARBONATO / POLYCARBONATE	1	9004/W	-	1

Prezzi su richiesta / Prices on request

GIUNTO AD L - POLARITA' ESTERNA
L-FEED - EXTERNAL POLARITY

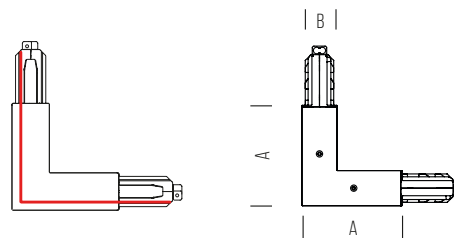

DIMENSIONI	A	B
1	89,7	25,4

IP20

ARTICOLO	VARIANTE	MATERIALE	MISURE	CODICE	EAN	IMBALLO
GIUNTO A L POLARITÀ ESTERNA	NERO / BLACK (RAL 9005)	POLICARBONATO / POLYCARBONATE	1	9012/B	-	1
GIUNTO A L POLARITÀ ESTERNA	BIANCO / WHITE (RAL 9010)	POLICARBONATO / POLYCARBONATE	1	9012/W	-	1

Prezzi su richiesta / Prices on request

GIUNTO AD L - POLARITA' INTERNA
L-FEED - INTERNAL POLARITY

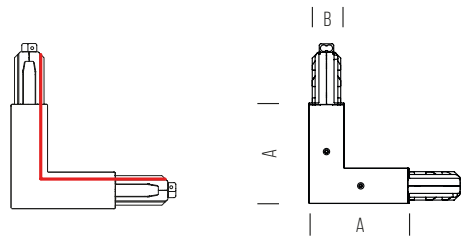

DIMENSIONI	A	B
1	89,7	25,4

IP20

ARTICOLO	VARIANTE	MATERIALE	MISURE	CODICE	EAN	IMBALLO
GIUNTO A L POLARITÀ INTERNA	NERO / BLACK (RAL 9005)	POLICARBONATO / POLYCARBONATE	1	9011/B	-	1
GIUNTO A L POLARITÀ INTERNA	BIANCO / WHITE (RAL 9010)	POLICARBONATO / POLYCARBONATE	1	9011/W	-	1

Prezzi su richiesta / Prices on request

TESTATA ALIMENTAZIONE - DESTRO
END-FEED - RIGHT

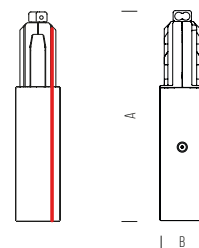
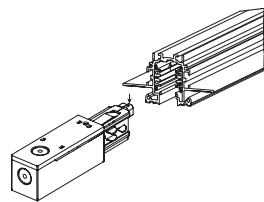

DIMENSIONI	A	B
1	95	31,4

IP20

ARTICOLO	VARIANTE	MATERIALE	MISURE	CODICE	EAN	IMBALLO
TESTATA DI ALIMENTAZIONE POLARITÀ DESTRA	NERO / BLACK (RAL 9005)	POLICARBONATO / POLYCARBONATE	1	9001/B	-	1
TESTATA DI ALIMENTAZIONE POLARITÀ DESTRA	BIANCO / WHITE (RAL 9010)	POLICARBONATO / POLYCARBONATE	1	9001/W	-	1

Prezzi su richiesta / Prices on request

TESTA ALIMENTAZIONE - SINISTRO

END-FEED - LEFT

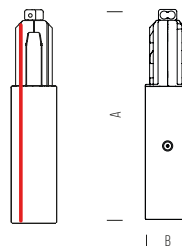
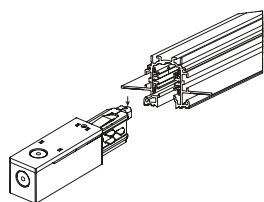

DIMENSIONI	A	B
1	95	31,4

IP20

ARTICOLO

VARIANTE

MATERIALE

MISURE

CODICE

EAN

IMBALLO

TESTATA DI ALIMENTAZIONE POLARITÀ SINISTRA	NERO / BLACK (RAL 9005)	POLICARBONATO / POLYCARBONATE	1	9002/B	-	1
TESTATA DI ALIMENTAZIONE POLARITÀ SINISTRA	BIANCO / WHITE (RAL 9010)	POLICARBONATO / POLYCARBONATE	1	9002/W	-	1

Prezzi su richiesta / Prices on request

GIUNTO PASSANTE

JOINTING CONNECTOR

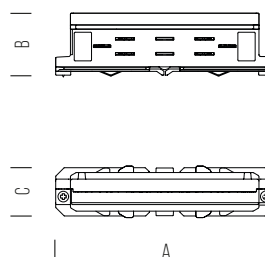
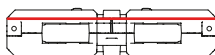

DIMENSIONI	A	B	C
1	114,7	32,6	25,4

IP20

ARTICOLO

VARIANTE

MATERIALE

MISURE

CODICE

EAN

IMBALLO

GIUNTO PASSANTE PER BINARIO	NERO / BLACK (RAL 9005)	POLICARBONATO / POLYCARBONATE	1	9003/B	-	1
GIUNTO PASSANTE PER BINARIO	BIANCO / WHITE (RAL 9010)	POLICARBONATO / POLYCARBONATE	1	9003/W	-	1

Prezzi su richiesta / Prices on request

GIUNTO DIRETTO CON ALIMENTAZIONE AL CENTRO
MIDDLE FEED FOR 2 CIRCUITS APPLICATION

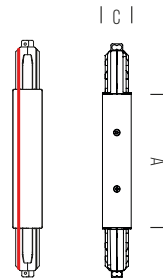

DIMENSIONI	A	B
1	148	25.4

IP20

ARTICOLO	VARIANTE	MATERIALE	MISURE	CODICE	EAN	IMBALLO
GIUNTO DIRETTO CON ALIMENTAZIONE DAL CENTRO	NERO / BLACK (RAL 9005)	POLICARBONATO / POLYCARBONATE	1	9010/B	-	1
GIUNTO DIRETTO CON ALIMENTAZIONE DAL CENTRO	BIANCO / WHITE (RAL 9010)	POLICARBONATO / POLYCARBONATE	1	9010/W	-	1

Prezzi su richiesta / Prices on request

KIT FISSAGGIO A SOSPENSIONE
COMPLETE SUSPENSION KIT

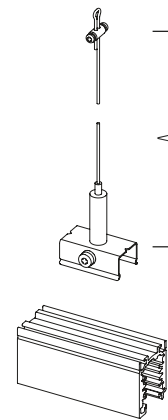

DIMENSIONI	A
1	1500
2	3000
3	5000

IP20

ARTICOLO	VARIANTE	MISURE	CODICE	EAN	IMBALLO
KIT COMPLETO PER FISSAGGIO A SOSPENSIONE BINARIO - 1,5 M	ACCIAIO / STEEL	1	9000-KIT1-1.5	-	1
KIT COMPLETO PER FISSAGGIO A SOSPENSIONE BINARIO - 3 M	ACCIAIO / STEEL	2	9000-KIT1-3	-	1
KIT COMPLETO PER FISSAGGIO A SOSPENSIONE BINARIO - 5 M	ACCIAIO / STEEL	3	9000-KIT1-5	-	1

Prezzi su richiesta / Prices on request

SISTEMA MODULARE DI BARRE LED T5

T5 LED BARS - MODULAR SYSTEM

AGGIORNATO

BTL CATEGORIA SCONTO 23

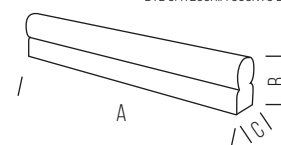

DIMENSIONI	A	B	C
1	317	36	23
2	578	36	23
3	1178	36	23

IT

- Sistema modulare a LED per creare una sorgente luminosa lineare e continua
- Connettore integrato per giunzione diretta senza ombre
- Massimo carico 110W, corrispondenti a 7 apparecchi da 16W (8,4m)
- Fornito con cavetto di alimentazione e clip di fissaggio a muro
- Cavo di interconnessione flessibile fornito separatamente (sacchetto da 5pz)

EN

- Modular LED system to create a continuous linear light source
- Integrated connector for direct connection without shadow gaps
- Maximum load 110W, corresponding to 7 x 16W luminaires (8.4m)
- Supplied with power cord and wall mounting clips
- Interconnecting flex cable supplied separately (bag with 5pcs)

IP20
15.000 H
INSTANT
CLASS II
-20° +40°

POTENZA WATT	BASE	KELVIN	LUMEN LM	FASCIO °	MISURE MM	VARIANTE	CODICE	EAN	IMBALLO	€ IVA ESCLUSA
4	-	3000	300	160	1	-	LD3BAR03042	8031453022815	1/10	7,42
4	-	4000	320	160	1	-	LD3BAR03043	8031453022822	1/10	7,42
8	-	3000	640	160	2	-	LD3BAR06082	8031453022839	1/10	9,01
8	-	4000	680	160	2	-	LD3BAR06083	8031453022846	1/10	9,01
16	-	3000	1300	160	3	-	LD3BAR12162	8031453022853	1/10	11,13
16	-	4000	1350	160	3	-	LD3BAR12163	8031453022860	1/10	11,13

KIT CAVO DI INTERCONNESSIONE DA 25CM (SET DA 5 PEZZI)

INTERCONNECTION CABLE KIT 25CM (SET OF 5 PIECES)

CODICE

EAN

€ IVA ESCLUSA

LD3BARCC250X5

8031453022884

8,48

SHOT S-FLAT LED

AGGIORNATO

BTL CATEGORIA SCONTO 23

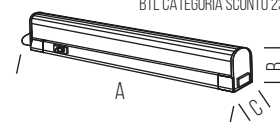

DIMENSIONI	A	B	C
1	288	36	28
2	516	36	28
3	849	36	28
4	1149	36	28
5	1449	36	28



COMPRESO DI CAVO DI ALIMENTAZIONE DA 1800MM E CAVO DI INTERCONNESSIONE DA 150 MM /
 INCLUDING 1800MM POWER CABLE AND 150MM INTERCONNECTION CABLE



MAX 12 PEZZI COLLEGATI IN SERIE
 MAX 12 PIECES CONNECTED IN SERIES

IT

- Gamma completa di reglette a led con interruttore per sostituzione delle tradizionali reglette T5
- Disponibile luce 3000K/4000K disponibili in cinque potenze e misure
- Cavo di alimentazione da 1800mm e cavo di interconnessione da 150mm inclusi
- Possibilità di collegamento in serie fino a 12 pezzi

EN

- Complete range of LED reglette with switch to replace conventional T5 reglette
- Available light 3000K/4000K available in five power outputs and sizes
- Power cable 1800mm and 150mm interconnecting flex included
- Possibility of connecting up to 12 pieces in series



POTENZA WATT	BASE	KELVIN	LUMEN LM	FASCIO °	MISURE MM	VARIANTE	CODICE	EAN	IMBALLO	€ IVA ESCLUSA
4	-	3000	320	140	1	-	YGS042B	8031453006853	1/10	13,99
4	-	4000	350	140	1	-	YGS043B	8031453006877	1/10	13,99
7	-	3000	600	140	2	-	YGS072B	8031453006891	1/10	16,54
7	-	4000	630	140	2	-	YGS073B	8031453006914	1/10	16,54
13	-	3000	1100	140	3	-	YGS132B	8031453006938	1/10	20,88
13	-	4000	1150	140	3	-	YGS133B	8031453006952	1/10	20,88
18	-	3000	1580	140	4	-	YGS182B	8031453006976	1/10	24,06
18	-	4000	1650	140	4	-	YGS183B	8031453007201	1/10	24,06
22	-	3000	1920	140	5	-	YGS222B	8031453007683	1/10	27,98
22	-	4000	2000	140	5	-	YGS223B	8031453007706	1/10	27,98



STRIP LED 12V
12V LED STRIP

BTL CATEGORIA SCONTO 23



IT

- Strisce a led adesive (tranne versioni IP67) ad alta potenza con alimentazione a 12V DC
- Lunghezza del rotolo 5 metri, striscia ritagliabile ogni 5 cm.
- Driver ad alta efficienza con carico max 6W-15W-30W-60W-75W da ordinare separatamente
- Opzionali cavetti di alimentazione, connettori di interconnessione, accessori per il montaggio
- Protezione: IP20 – IP65 – IP67

EN

- Adhesive (except IP67 versions) high power LED strips with 12V DC power supply
- Roll length 5 metres, strip can be cut every 5 cm
- High efficiency driver with max. load 6W-15W-30W-60W-75W, to be ordered separately
- Optional power cords, interconnection couplers, mounting accessories
- Protection rating: IP20 – IP65 – IP67

IP20 IP65 IP67

15.000H

INSTANT

-20° +40°

NOT DIMMABLE

POTENZA WATT	IP	KELVIN	LUMEN LM	FASCIO °	MISURE MM	NUMERO LED	CODICE	EAN	IMBALLO	€ IVA ESCLUSA
24	20	3000	320 X METRO	120	5000 X 8 X 3	300	LD1STR242IP20	8031453002527	1/10	34,45
24	20	4000	320 X METRO	120	5000 X 8 X 3	300	LD1STR243IP20	8031453002534	1/10	34,45
48	20	3000	660 X METRO	120	5000 X 8 X 3	600	LD1STR482IP20	8031453002541	1/10	55,12
48	20	4000	660 X METRO	120	5000 X 8 X 3	600	LD1STR483IP20	8031453002558	1/10	55,12
72	65	3000	1100 X METRO	120	5000 X 12 X 3	300	LD1STR722IP65	8031453001841	1/10	72,08
72	65	4000	1100 X METRO	120	5000 X 12 X 3	300	LD1STR723IP65	8031453001865	1/10	72,08
72	67	3000	1100 X METRO	120	5000 X 12 X 3	300	LD1STR722IP67	8031453001858	1/10	75,79
72	67	4000	1100 X METRO	120	5000 X 12 X 3	300	LD1STR723IP67	8031453001872	1/10	75,79

STRIP LED 24V

24V LED STRIP

BTL CATEGORIA SCONTO 23



IT

- Strisce a led adesive ad alta potenza con alimentazione a 24V DC
- Lunghezza del rotolo 5 metri, striscia ritagliabile ogni 10 cm.
- Driver ad alta efficienza con carico max 6W-15W-30W-60W-75W da ordinare separatamente
- Opzionali cavetti di alimentazione, connettori di interconnessione, accessori per il montaggio
- Protezione: IP20 – IP65

EN

- Adhesive high power LED strips with 24V DC power supply
- Roll length 5 metres, strip can be cut every 10 cm.
- High efficiency driver with max. load 6W-15W-30W-60W-75W, to be ordered separately
- Optional power cords, interconnection couplers, mounting accessories
- Protection rating: IP20 – IP65



POTENZA WATT	IP	KELVIN	LUMEN LM	FASCIO °	MISURE MM	NUMERO LED	CODICE	EAN	IMBALLO	€ IVA ESCLUSA
24	20	3000	500 X METRO	120	5000	300	LD2STR242IP20	8031453019235	1/10	30,74
24	20	4000	500 X METRO	120	5000	300	LD2STR243IP20	8031453019242	1/10	30,74
48	20	3000	1000 X METRO	120	5000	600	LD2STR482IP20	8031453019259	1/10	43,99
48	20	4000	1000 X METRO	120	5000	600	LD2STR483IP20	8031453019266	1/10	43,99
72	65	3000	1300 X METRO	120	5000	300	LD2STR722IP65	8031453019273	1/10	66,14
72	65	4000	1300 X METRO	120	5000	300	LD2STR723IP65	8031453019280	1/10	66,14

DRIVER PER STRIP LED
STRIP LED DRIVER

BTL CATEGORIA SCONTO 23

IP20

DRIVER PER STRIP LED 12V	MISURE MM	CODICE	EAN	IMBALLO	€ IVA ESCLUSA
Led driver 12V DC - 6 Watt Max	82 X 43 X 23	LD1STRD06	8031453002565	1/10	10,92
Led driver 12V DC - 15 Watt Max	123 X 45 X 19	LD1STRD15	8031453001889	1/10	14,52
Led driver 12V DC - 30 Watt Max	166 X 52 X 24	LD1STRD30	8031453001896	1/10	25,76
Led driver 12V DC - 60 Watt Max	180 X 52 X 30	LD1STRD60	8031453001902	1/10	37,42
Led driver 12V DC - 75 Watt Max	180 X 52 X 30	LD1STRD75	8031453002572	1/10	45,37

DRIVER PER STRIP LED 24V	MISURE MM	CODICE	EAN	IMBALLO	€ IVA ESCLUSA
Led driver 24V DC - 6 Watt Max	82 X 43 X 23	LD2STRD06	8031453019419	1/10	11,77
Led driver 24V DC - 15 Watt Max	123 X 45 X 19	LD2STRD15	8031453019426	1/10	12,08
Led driver 24V DC - 30 Watt Max	153 X 42 X 32	LD2STRD30	8031453019297	1/10	25,44
Led driver 24V DC - 60 Watt Max	180 X 52 X 30	LD2STRD60	8031453019303	1/10	30,74
Led driver 24V DC - 75 Watt Max	180 X 52 X 30	LD2STRD75	8031453019310	1/10	33,81

ACCESSORI PER STRIP LED	MISURE MM	CODICE	EAN	IMBALLO	€ IVA ESCLUSA
* Cavetto di alimentazione per LED Strip 24-48W	-	LD1STRCA1	8031453002596	1X5 PZ	6,04
* Cavetto di connessione per LED Strip 24-48W	-	LD1STRCC1	8031453002589	1X5 PZ	10,81
* Cavetto di alimentazione small per LED Strip 72W	-	LD1STRCA2	8031453003005	1X5 PZ	6,04
* Cavetto di interconnessione small per LED Strip 72W	-	LD1STRCC2	8031453003012	1X5 PZ	10,81
* Connettore di interconnessione small senza cavo per LED Strip 72W	-	LD1STRCC3	8031453003135	1X5 PZ	10,18
** Sacchetto di accessori comprendente 20 clips per il fissaggio delle strisce e 5 caps di isolamento connettori per strisce led IP65	-	LD1STRSACIP65	8031453002121	1	4,45
** Sacchetto di accessori comprendente 20 clips per il fissaggio delle strisce e 5 caps di isolamento connettori per strisce led IP67	-	LD1STRSACIP67	8031453002138	1	4,45

* Carico max 70W(24V) - 35W(12V)

** L'utilizzo dei caps di isolamento e dei cavi di interconnessione non garantiscono il grado IP iniziale delle strisce, pertanto si consiglia in abbinata a tali accessori di attuare degli accorgimenti tali (isolamento con silicone o altri sistemi) da poter considerare l'installazione di grado IP adeguato al luogo dove viene realizzata.

** The use of insulation caps and interconnection cables do not guarantee the initial IP degree of the strips, therefore it is recommended in combination with these accessories to implement such precautions (insulation with silicone or other systems). The IP degree must be suitable for the place where the installation is made.

MOD-A

MODULO LED CIRCOLARE MAGNETICO DI SECONDA GENERAZIONE
SECOND GENERATION MAGNETIC CIRCULAR LED MODULE

AGGIORNATO

BTL CATEGORIA SCONTO 23

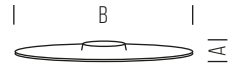

DIMENSIONI	A	B
1	27	128
2	27	152
3	27	168



IT

- Modulo a LED con alimentatore incorporato per retrofit su plafoniere esistenti.
- Installazione rapida grazie a supporti magnetici, necessita solo del collegamento dell'alimentazione (isolamento classe II)
- Disponibili diverse misure e potenze per adattarsi ai diversi apparecchi esistenti

EN

- LED module with built-in driver to retrofit existing ceiling light fixtures.
- Quick installation thanks to magnetic supports, only requires connection to the power supply (insulation class II)
- Various sizes and power outputs available to adapt to different existing luminaires

IP20

220v
240v

30.000 H

INSTANT

CLASS II

-20° **+40°**

NOT DIMMABLE

POTENZA WATT	BASE	KELVIN	LUMEN LM	FASCIO °	MISURE MM	VARIANTE	CODICE	EAN	IMBALLO	€ IVA ESCLUSA
12	-	3000	1200	160	1	-	MODA122B	8031453021498	1/10	13,36
12	-	4000	1200	160	1	-	MODA123B	8031453021504	1/10	13,36
17	-	3000	1900	160	2	-	MODA172B	8031453021511	1/10	16,01
17	-	4000	1900	160	2	-	MODA173B	8031453021528	1/10	16,01
22	-	3000	2500	160	3	-	MODA222B	8031453021535	1/10	18,34
22	-	4000	2500	160	3	-	MODA223B	8031453021542	1/10	18,34

MOD-B

MODULO LED CIRCOLARE MAGNETICO DI SECONDA GENERAZIONE
 SECOND GENERATION MAGNETIC CIRCULAR LED MODULE

BTL CATEGORIA SCONTO 23

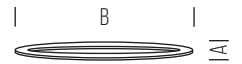

DIMENSIONI	A	B
1	27	203



IT

- Modulo a LED con alimentatore incorporato per retrofit su plafoniere esistenti.
- Installazione rapida grazie a supporti magnetici, necessita solo del collegamento dell'alimentazione (isolamento classe II)
- Versione con foro centrale, ideale per sostituzione in plafoniere con foro passante

EN

- LED module with built-in driver to retrofit existing ceiling light fixtures.
- Quick installation thanks to magnetic supports, only requires connection to the power supply (insulation class II)
- Central hole version, suitable for retrofit in pass-through hole fixtures



POTENZA WATT	BASE	KELVIN	LUMEN LM	FASCIO °	MISURE MM	VARIANTE	CODICE	EAN	IMBALLO	€ IVA ESCLUSA
20	-	3000	2000	160	1	-	MODB202B	8031453021726	1/10	21,73
20	-	4000	2000	160	1	-	MODB203B	8031453021733	1/10	21,73

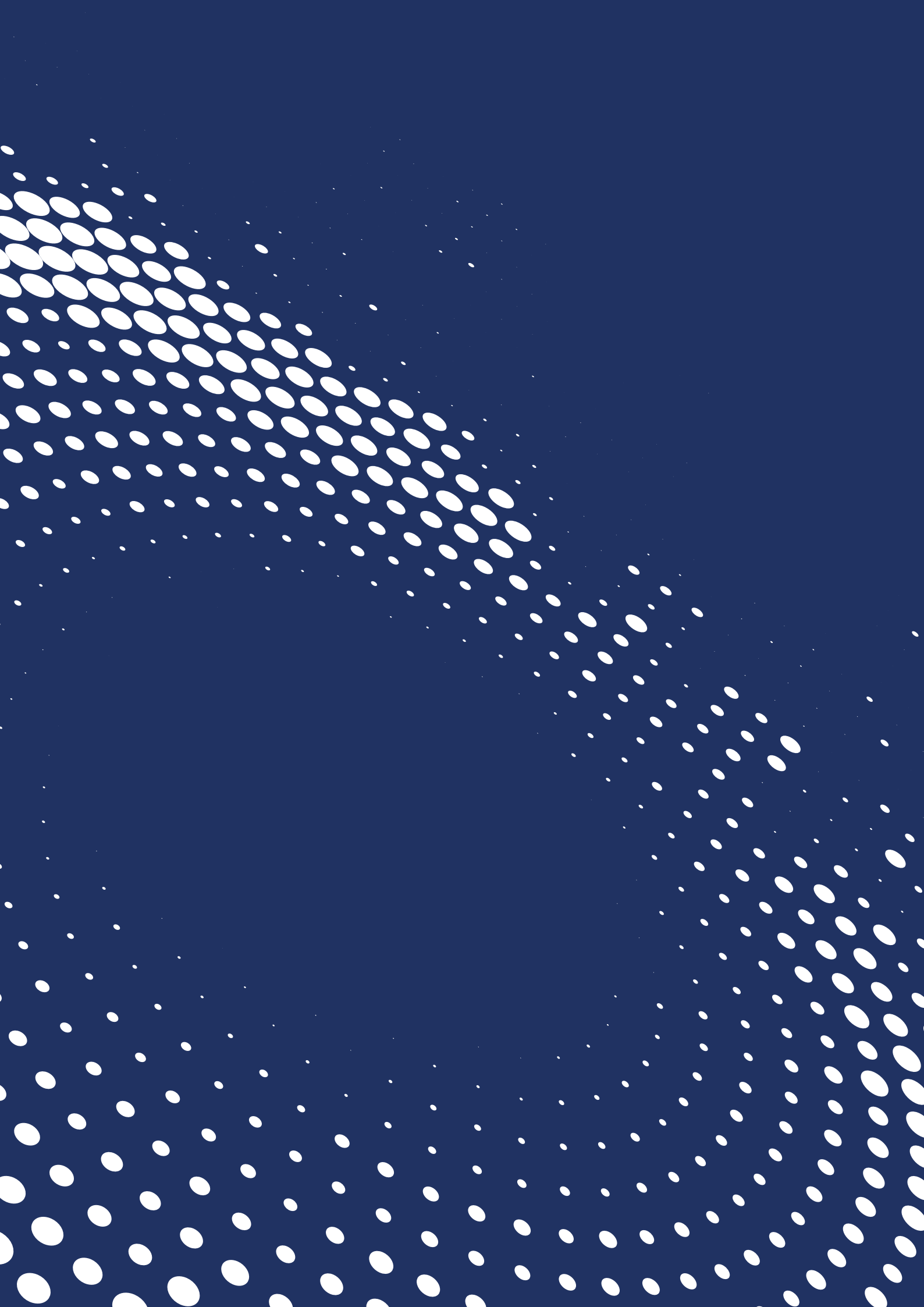

A decorative graphic in the bottom-left corner consisting of a series of white dots of varying sizes, arranged in a pattern that suggests a trail or a cluster of particles.

OUTDOOR TECNICO
TECHNICAL OUTDOOR

ORLANDO 10
PROIETTORE A LED
LED FLOODLIGHT

AGGIORNATO

BTL CATEGORIA SCONTO 24

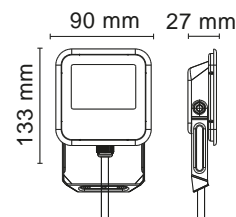

IT

- Proiettore a LED slim con tecnologia 'Driver On Board' (DOB)
- Efficienza 90 lm/W
- Corpo in alluminio verniciato e diffusore in vetro temperato
- Colore bianco RAL 9016 o grigio RAL 7024

EN

- Slim LED floodlight with 'Driver On Board' (DOB) technology
- Efficiency 90 lm / W
- Painted aluminum body with tempered glass diffuser
- White RAL 9016 or grey RAL 7024 colors

IP65

IK06

50.000 H

INSTANT

CLASS I

-20° +40°

220V 240V

NOT DIMMABLE

POTENZA WATT	BASE	KELVIN	LUMEN LM	FASCIO °	MISURE MM	VARIANTE	CODICE	EAN	IMBALLO	€ IVA ESCLUSA
10	-	3000	900	100	1	BIANCO / WHITE	ORLANDO10B	8031453023300	1/30	10,18
10	-	4000	900	100	1	GRIGIO / GREY	ORLANDO10G	8031453023256	1/30	10,18

ORLANDO 20 - 20PIR

PROIETTORE A LED
LED FLOODLIGHT

AGGIORNATO

BTL CATEGORIA SCONTO 24

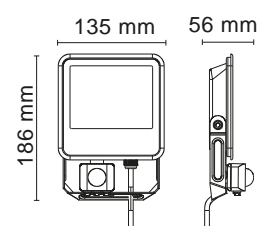
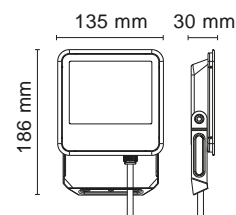

IT

- Proiettore a LED slim con tecnologia 'Driver On Board' (DOB)
- Alta efficienza 110 lm/W
- Corpo in alluminio verniciato e diffusore in vetro temperato
- Colore bianco RAL 9016 o grigio RAL 7024 - PIR solo colore grigio RAL 7024.
- Versione PIR*: sensore programmabile (sensibilità, livello di luce ambiente, durata)

EN

- Slim LED floodlight with 'Driver On Board' (DOB) technology
- High efficiency 110 lm / W
- Painted aluminum body with tempered glass diffuser
- White RAL 9016 or grey RAL 7024 colors - PIR version only in grey RAL 7024.
- PIR version*: programmable sensor (sensitivity, ambient light level, duration)



POTENZA WATT	BASE	KELVIN	LUMEN LM	FASCIO °	MISURE MM	VARIANTE	CODICE	EAN	IMBALLO	€ IVA ESCLUSA
20	-	3000	2200	100	1	BIANCO / WHITE	ORLANDO20B	8031453023317	1/20	21,20
20	-	4000	2200	100	1	BIANCO / WHITE	ORLANDO20BN	8031453024741	1/20	21,20
20	-	4000	2200	100	1	GRIGIO / GREY	ORLANDO20G	8031453023263	1/20	21,20
20	-	6500	2200	100	1	GRIGIO / GREY	ORLANDO20GD	8031453024758	1/20	21,20
20	-	4000	2200	100	2	GRIGIO / GREY - PIR SENSOR*	ORLANDO20GIR	8031453023355	1/20	37,10

ORLANDO 30 - 30PIR

PROIETTORE A LED
LED FLOODLIGHT

AGGIORNATO

BTL CATEGORIA SCONTO 24

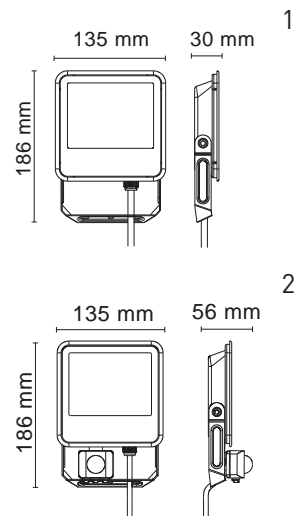

IT

- Proiettore a LED slim con tecnologia 'Driver On Board' (DOB)
- Alta efficienza 110 lm/W
- Corpo in alluminio verniciato e diffusore in vetro temperato
- Colore bianco RAL 9016 o grigio RAL 7024 - PIR solo colore grigio RAL 7024.
- Versione PIR*: sensore programmabile (sensibilità, livello di luce ambiente, durata)

EN

- Slim LED floodlight with 'Driver On Board' (DOB) technology
- High efficiency 110 lm / W
- Painted aluminum body with tempered glass diffuser
- White RAL 9016 or grey RAL 7024 colors - PIR version only in grey RAL 7024.
- PIR version*: programmable sensor (sensitivity, ambient light level, duration)



POTENZA WATT	BASE	KELVIN	LUMEN LM	FASCIO °	MISURE MM	VARIANTE	CODICE	EAN	IMBALLO	€ IVA ESCLUSA
30	-	3000	3300	100	1	BIANCO / WHITE	ORLANDO30B	8031453023324	1/20	26,50
30	-	4000	3300	100	1	BIANCO / WHITE	ORLANDO30BN	8031453024765	1/20	26,50
30	-	4000	3300	100	1	GRIGIO / GREY	ORLANDO30G	8031453023270	1/20	26,50
30	-	6500	3300	100	1	GRIGIO / GREY	ORLANDO30GD	8031453024772	1/20	26,50
30	-	4000	3300	100	2	GRIGIO / GREY - PIR SENSOR*	ORLANDO30GIR	8031453023362	1/20	42,40

ORLANDO 50
PROIETTORE A LED
LED FLOODLIGHT

AGGIORNATO

BTL CATEGORIA SCONTO 24

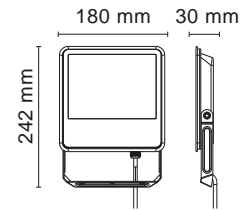

IT

- Proiettore a LED slim con tecnologia 'Driver On Board' (DOB)
- Alta efficienza 110 lm/W
- Corpo in alluminio verniciato e diffusore in vetro temperato
- Colore bianco RAL 9016 o grigio RAL 7024

EN

- Slim LED floodlight with 'Driver On Board' (DOB) technology
- High efficiency 110 lm / W
- Painted aluminum body with tempered glass diffuser
- White RAL 9016 or grey RAL 7024 colors

IP65

IK06

50.000 H

INSTANT

CLASS I

-20° +40°

220V
240V

NOT DIMMABLE

POTENZA WATT	BASE	KELVIN	LUMEN LM	FASCIO °	MISURE MM	VARIANTE	CODICE	EAN	IMBALLO	€ IVA ESCLUSA
50	-	3000	5500	100	1	BIANCO / WHITE	ORLANDO50B	8031453023331	1/10	34,98
50	-	4000	5500	100	1	BIANCO / WHITE	ORLANDO50BN	8031453024789	1/10	34,98
50	-	4000	5500	100	1	GRIGIO / GREY	ORLANDO50G	8031453023287	1/10	34,98
50	-	6500	5500	100	1	GRIGIO / GREY	ORLANDO50GD	8031453024796	1/10	34,98

ORLANDO 90
PROIETTORE A LED
LED FLOODLIGHT

AGGIORNATO

BTL CATEGORIA SCONTO 24

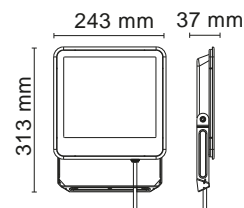

IT

- Proiettore a LED slim con tecnologia 'Driver On Board' (DOB)
- Alta efficienza 110 lm/W
- Corpo in alluminio verniciato e diffusore in vetro temperato
- Colore bianco RAL 9016 o grigio RAL 7024
- Valvola integrata per espulsione della condensa

EN

- Slim LED floodlight with 'Driver On Board' (DOB) technology
- High efficiency 110 lm / W
- Painted aluminum body with tempered glass diffuser
- White RAL 9016 or grey RAL 7024 colors
- Integrated valve to in order to avoid condensation



50.000 H

INSTANT

CLASS I

-20° +40°

220v / 240v

NOT DIMMABLE

POTENZA WATT	BASE	KELVIN	LUMEN LM	FASCIO °	MISURE MM	VARIANTE	CODICE	EAN	IMBALLO	€ IVA ESCLUSA
90	-	3000	9900	110	1	BIANCO / WHITE	ORLANDO90B	8031453023348	1/5	61,48
90	-	4000	9900	110	1	BIANCO / WHITE	ORLANDO90BN	8031453024802	1/5	61,48
90	-	4000	9900	110	1	GRIGIO / GREY	ORLANDO90G	8031453023294	1/5	61,48
90	-	6500	9900	110	1	GRIGIO / GREY	ORLANDO90GD	8031453024819	1/5	61,48

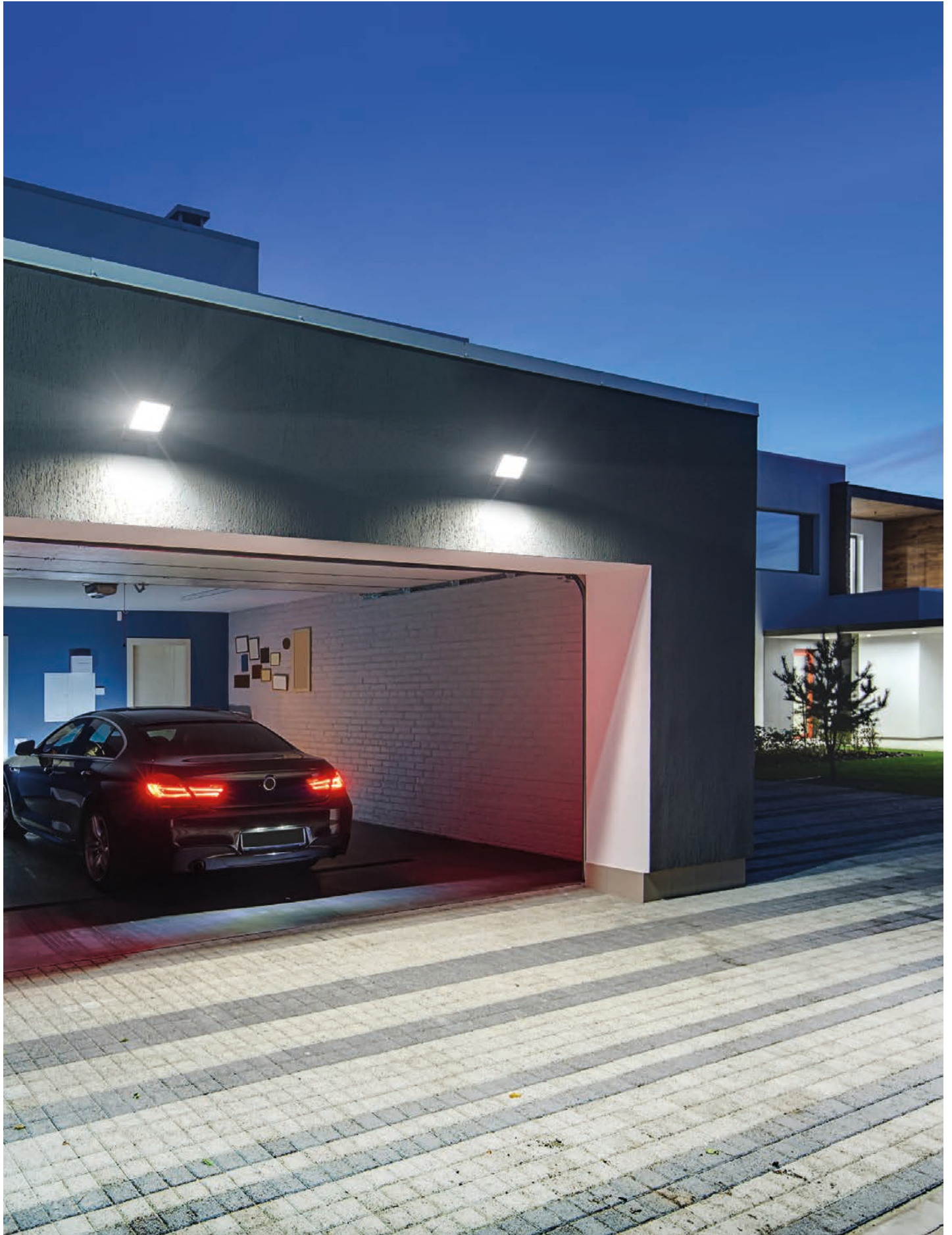

DENVER

PROIETTORE A LED SLIM
SLIM LED FLOODLIGHT

BTL CATEGORIA SCONTO 24

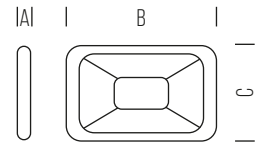

DIMENSIONI	A	B	C
1	20	152	105
2	30	232	155
3	40	300	203



IT

- Proiettore a LED ultrapiatto con tecnologia Driver On Board (DOB)
- Disponibili 3 temperature colore e 4 tagli di potenza
- Corpo in alluminio pressofuso verniciato

EN

- Ultra-flat LED floodlight with 'Driver On Board' (DOB) technology
- Available in 3 colour temperatures and 4 power levels
- Painted die-cast aluminium body

IP65



20.000 H



CLASS I



POTENZA WATT	BASE	KELVIN	LUMEN LM	FASCIO °	MISURE MM	VARIANTE	CODICE	EAN	IMBALLO	€ IVA ESCLUSA
12	-	3000	1000	120	1	BIANCO / WHITE	DENVER1000BW	8031453020187	1/10	14,84
12	-	4000	1000	120	1	NERO / BLACK	DENVER1000N	8031453020194	1/10	14,84
12	-	6500	1000	120	1	NERO / BLACK	DENVER1000ND	8031453020200	1/10	14,84
25	-	3000	2100	120	2	BIANCO / WHITE	DENVER2000BW	8031453020217	1/4	32,86
25	-	4000	2100	120	2	NERO / BLACK	DENVER2000N	8031453020224	1/4	32,86
25	-	6500	2100	120	2	NERO / BLACK	DENVER2000ND	8031453020231	1/4	32,86
36	-	3000	3000	120	2	BIANCO / WHITE	DENVER3000BW	8031453020255	1/4	39,22
36	-	4000	3000	120	2	NERO / BLACK	DENVER3000N	8031453020262	1/4	39,22
36	-	6500	3000	120	2	NERO / BLACK	DENVER3000ND	8031453020279	1/4	39,22
60	-	3000	5000	120	3	BIANCO / WHITE	DENVER5000BW	8031453020293	1/4	58,30
60	-	4000	5000	120	3	NERO / BLACK	DENVER5000N	8031453020309	1/4	58,30
60	-	6500	5000	120	3	NERO / BLACK	DENVER5000ND	8031453020316	1/4	58,30

DENVER

PROIETTORE A LED SLIM CON SENSORE DI MOVIMENTO A MICROONDE
 LED SLIM FLOODLIGHT WITH MICROWAVE MOTION SENSOR

BTL CATEGORIA SCONTO 24

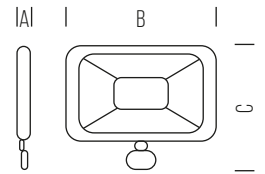

DIMENSIONI	A	B	C
1	50	232	218



IT

- Proiettore a LED con tecnologia Driver On Board (DOB)
- Sensore di movimento a microonde regolabile:
 - Sensibilità luce ambientale: 2-2000 lux
 - Distanza di rilevamento: 2 - 12m
 - Tempo di accensione: 5sec - 10min
- Corpo in alluminio pressofuso verniciato

EN

- LED floodlight with 'Driver On Board' (DOB) technology
- Adjustable microwave motion sensor:
 - Ambient light sensitivity: 2-2000 lux
 - Detection distance: 2 - 12m
 - Light-on time: 5sec - 10min
- Painted die-cast aluminium body

IP44
220v / 240v
20.000 H
INSTANT
-20° +40°
RADAR
m
NOT DIMMABLE

POTENZA WATT	BASE	KELVIN	LUMEN LM	FASCIO °	MISURE MM	VARIANTE	CODICE	EAN	IMBALLO	€ IVA ESCLUSA
25	-	4000	2100	120	1	NERO / BLACK	DENVER2000NMW	8031453022358	1/4	51,94
36	-	4000	3000	120	1	NERO / BLACK	DENVER3000NMW	8031453022365	1/4	58,30

KYOTO 100

 PROIETTORE A LED PROFESSIONALE
 PROFESSIONAL LED FLOODLIGHT

AGGIORNATO

BTL CATEGORIA SCONTO 24

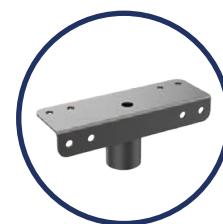
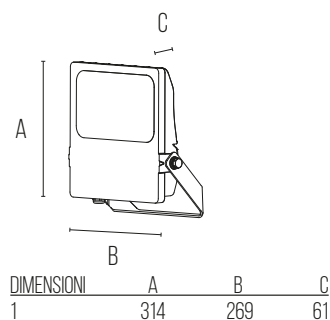
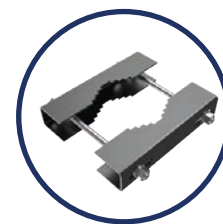
 Accessorio testa per palo /
 Pole adaptor

 Accessorio morsa per palo /
 Clamp bracket

IT

- Proiettore a LED professionale
- Alta efficienza 150 lm/W
- Corpo in alluminio pressofuso verniciato e diffusore in vetro temperato
- Disponibile con tre differenti fasci, Asimmetrico 120x50°(Tipo III), Concentrato 60° e Flood 120°
- Valvola di sfogo per evitare la formazione di condensa all'interno del proiettore
- Indice di protezione IP66
- Protezione dalle sovratensioni di 6KV linea-linea
- Protezione dalle sovratensioni di 10KV linea-terra
- Colore RAL9006

EN

- Professional LED projector
- High efficiency 150 lm / W
- Body in painted die-cast aluminum and diffuser in tempered glass
- Available with three different beams, Asymmetrical 120x50° (Type III), Concentrated 60 ° and Flood 120 °
- External vent to avoid condensation inside the projector
- Protection index IP66
- Overvoltage protection of 6KV line-line
- Overvoltage protection of 10KV line-earth
- RAL9006 color

IP66
50.000 H
INSTANT
CLASS I
-30° **+50°**
220V
240V
NOT
DIMMABLE

POTENZA WATT	BASE	KELVIN	LUMEN LM	FASCIO °	MISURE MM	VARIANTE	CODICE	EAN	IMBALLO	€ IVA ESCLUSA
100	-	4000	15000	60	1	CONCENTRATO / CONCENTRATED	KYOTO1004G	8031453023416	1	238,50
100	-	4000	15000	120	1	FLOOD	KYOTO1005G	8031453023423	1	238,50
100	-	4000	15000	120X50	1	ASIMMETRICO / ASYMMETRIC	KYOTO100AG	8031453023430	1	238,50
TESTA PALO PER PROIETTORE / POLE ADAPTOR KYOTO							KYOTO-TP60	8031453023614	1/10	53,00
MORSA PALO PER PROIETTORE / CLAMP BRACKET KYOTO							KYOTO-M150	8031453023621	1/10	32,86

KYOTO 150

PROIETTORE A LED PROFESSIONALE
 PROFESSIONAL LED FLOODLIGHT

AGGIORNATO

BTL CATEGORIA SCONTO 24

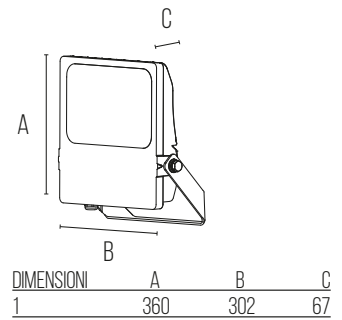

Accessorio testa per palo / Pole adaptor

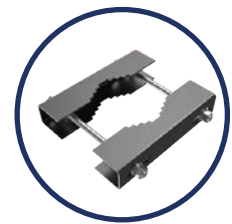

Accessorio morsa per palo / Clamp bracket

IT

- Proiettore a LED professionale
- Alta efficienza 150 lm/W
- Corpo in alluminio pressofuso verniciato e diffusore in vetro temperato
- Disponibile con tre differenti fasci, Asimmetrico 120x50°(Tipo III), Concentrato 60° e Flood 120°
- Valvola di sfogo per evitare la formazione di condensa all'interno del proiettore
- Indice di protezione IP66
- Protezione dalle sovratensioni di 6KV linea-linea
- Protezione dalle sovratensioni di 10KV linea-terra
- Colore RAL9006

EN

- Professional LED projector
- High efficiency 150 lm / W
- Body in painted die-cast aluminum and diffuser in tempered glass
- Available with three different beams, Asymmetrical 120x50° (Type III), Concentrated 60 ° and Flood 120 °
- External vent to avoid condensation inside the projector
- Protection index IP66
- Overvoltage protection of 6KV line-line
- Overvoltage protection of 10KV line-earth
- RAL9006 color



POTENZA WATT	BASE	KELVIN	LUMEN LM	FASCIO °	MISURE MM	VARIANTE	CODICE	EAN	IMBALLO	€ IVA ESCLUSA
150	-	4000	22500	60	1	CONCENTRATO / CONCENTRATED	KYOTO15046	8031453023461	1	296,80
150	-	4000	22500	120	1	FLOOD	KYOTO15056	8031453023478	1	296,80
150	-	4000	22500	120X50	1	ASIMMETRICO / ASYMMETRIC	KYOTO150A6	8031453023485	1	296,80
TESTA PALO PER PROIETTORE / POLE ADAPTOR KYOTO							KYOTO-TP60	8031453023614	1/10	53,00
MORSA PALO PER PROIETTORE / CLAMP BRACKET KYOTO							KYOTO-M150	8031453023621	1/10	32,86

KYOTO 200

 PROIETTORE A LED PROFESSIONALE
 PROFESSIONAL LED FLOODLIGHT

AGGIORNATO

BTL CATEGORIA SCONTO 24

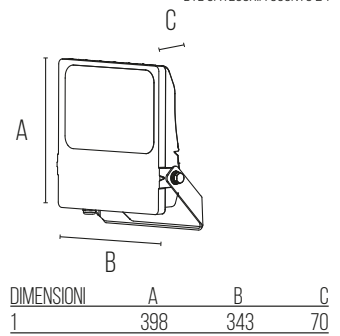
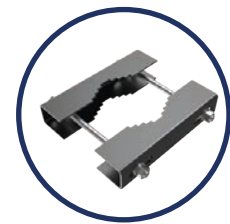
 Accessorio testa per palo /
 Pole adaptor

 Accessorio morsa per palo /
 Clamp bracket

IT

- Proiettore a LED professionale
- Alta efficienza 150 lm/W
- Corpo in alluminio pressofuso verniciato e diffusore in vetro temperato
- Disponibile con tre differenti fasci, Asimmetrico 120x50°(Tipo III), Concentrato 60° e Flood 120°
- Valvola di sfogo per evitare la formazione di condensa all'interno del proiettore
- Indice di protezione IP66
- Protezione dalle sovratensioni di 6KV linea-linea
- Protezione dalle sovratensioni di 10KV linea-terra
- Colore RAL9006

EN

- Professional LED projector
- High efficiency 150 lm / W
- Body in painted die-cast aluminum and diffuser in tempered glass
- Available with three different beams, Asymmetrical 120x50° (Type III), Concentrated 60 ° and Flood 120 °
- External vent to avoid condensation inside the projector
- Protection index IP66
- Overvoltage protection of 6KV line-line
- Overvoltage protection of 10KV line-earth
- RAL9006 color

IP66
50.000 H
INSTANT
CLASS I
-30° **+50°**
220V
240V
NOT DIMMABLE

POTENZA WATT	BASE	KELVIN	LUMEN LM	FASCIO °	MISURE MM	VARIANTE	CODICE	EAN	IMBALLO	€ IVA ESCLUSA
200	-	4000	30000	60	1	CONCENTRATO / CONCENTRATED	KYOTO2004G	8031453023515	1	360,40
200	-	4000	30000	120	1	FLOOD	KYOTO2005G	8031453023522	1	360,40
200	-	4000	30000	120X50	1	ASIMMETRICO / ASYMMETRIC	KYOTO200AG	8031453023539	1	360,40
TESTA PALO PER PROIETTORE / POLE ADAPTOR KYOTO							KYOTO-TP60	8031453023614	1/10	53,00
MORSA PALO PER PROIETTORE / CLAMP BRACKET KYOTO							KYOTO-M300	8031453023638	1/5	47,70

KYOTO 300

PROIETTORE A LED PROFESSIONALE
 PROFESSIONAL LED FLOODLIGHT

AGGIORNATO

BTL CATEGORIA SCONTO 24

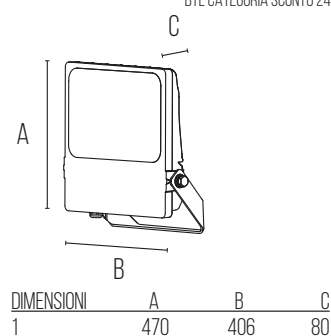

Accessorio testa per palo / Pole adaptor

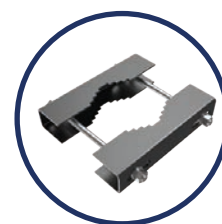

Accessorio morsa per palo / Clamp bracket

IT

- Proiettore a LED professionale
- Alta efficienza 150 lm/W
- Corpo in alluminio pressofuso verniciato e diffusore in vetro temperato
- Disponibile con tre differenti fasci, Asimmetrico 120x50°(Tipo III), Concentrato 60° e Flood 120°
- Valvola di sfogo per evitare la formazione di condensa all'interno del proiettore
- Indice di protezione IP66
- Protezione dalle sovratensioni di 6KV linea-linea
- Protezione dalle sovratensioni di 12KV linea-terra
- Colore RAL9006

EN

- Professional LED projector
- High efficiency 150 lm / W
- Body in painted die-cast aluminum and diffuser in tempered glass
- Available with three different beams, Asymmetrical 120x50° (Type III), Concentrated 60 ° and Flood 120 °
- External vent to avoid condensation inside the projector
- Protection index IP66
- Overvoltage protection of 6KV line-line
- Overvoltage protection of 12KV line-earth
- RAL9006 color



50.000H

INSTANT

CLASS I

-30° to +50°

220V / 240V

NOT DIMMABLE

POTENZA WATT	BASE	KELVIN	LUMEN LM	FASCIO °	MISURE MM	VARIANTE	CODICE	EAN	IMBALLO	€ IVA ESCLUSA
300	-	4000	45000	60	1	CONCENTRATO / CONCENTRATED	KYOTO30046	8031453023560	1	604,20
300	-	4000	45000	120	1	FLOOD	KYOTO30056	8031453023577	1	604,20
300	-	4000	45000	120X50	1	ASIMMETRICO / ASYMMETRIC	KYOTO300A6	8031453023584	1	604,20
TESTA PALO PER PROIETTORE / POLE ADAPTOR KYOTO							KYOTO-TP60	8031453023614	1/10	53,00
MORSA PALO PER PROIETTORE / CLAMP BRACKET KYOTO							KYOTO-M300	8031453023638	1/5	47,70

AKRON

PROIETTORE A LED 12/24V
12/24V LED FLOODLIGHT

BTL CATEGORIA SCONTO 24

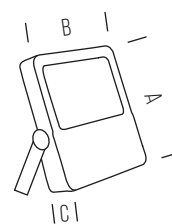

DIMENSIONI	A	B	C
1	185	155	50



IT

- Corpo in alluminio pressofuso verniciato e vetro frontale temperato
- Funzionamento a 12-24V AC/DC, ideale per imbarcazioni, camper e tutte le applicazioni in bassissima tensione.

EN

- Painted die-cast aluminium body and clear tempered glass
- 12-24V AC / DC fixture, ideal for boats, campers and all low voltage applications.

IP65

12/24V
AC/DC

25.000 H

INSTANT

CLASS III

-20° **+40°**

NOT DIMMABLE

POTENZA WATT	BASE	KELVIN	LUMEN LM	FASCIO °	MISURE MM	VARIANTE	CODICE	EAN	IMBALLO	€ IVA ESCLUSA
20	-	4000	1600	120	1	-	AKRON20NLV	8031453019648	1/4	43,46

STAND PER PROIETTORE
FLOODLIGHT STAND

BTL CATEGORIA SCONTO 24



ACCESSORIO / ACCESSORY:
 connettore stagno IP68 / IP68
 waterproof connector



ACCESSORIO / ACCESSORY:
 connettore stagno IP68 a due vie /
 two-way IP68 waterproof connector

IT

- Stand telescopico in alluminio adattabile a diversi modelli di proiettore (massimo 2 articoli)
- Altezza minima 67 cm, altezza massima 150cm
- Peso massimo consentito: 6+6 Kg

EN

- Telescopic aluminium stand, suitable for different models of floodlights (max 2 articles)
- minimum height 67 cm, maximum height 150 cm
- maximum weight allowed: 6+6 Kg

ALTEZZA	CODICE	EAN	IMBALLO	€ IVA ESCLUSA
MIN. 67CM - MAX.150CM- MAX 6+6 KG	STAND2	8031453024727	1/6	37,10
CONNETTORE STAGNO IP68 / IP68 WATERPROOF CONNECTOR	C1IP68	8031453024703	1	9,54
CONNETTORE STAGNO IP68 A DUE VIE / TWO-WAY IP68 WATERPROOF CONNECTOR	C2IP68	8031453024710	1	13,78

CACTUS
PROIETTORE STRADALE A LED
LED STREETLIGHT

BTL CATEGORIA SCONTO 24

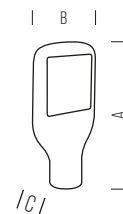

DIMENSIONI	A	B	C
1	335	180	78



IT

- Proiettore a LED stradale
- Lente con ottica asimmetrica 150°x90°
- Corpo in alluminio pressofuso verniciato
- Testa palo con diametro massimo di 70mm

EN

- LED street floodlight
- Lens with asymmetrical optics 150°x90°
- Painted die-cast aluminium body
- Post top with maximum diameter of 70mm

IP65

**220V
240V**

50.000 H

INSTANT

CLASS I

-30° +40°

NOT DIMMABLE

POTENZA WATT	BASE	KELVIN	LUMEN LM	FASCIO °	MISURE MM	VARIANTE	CODICE	EAN	IMBALLO	€ IVA ESCLUSA
50	-	4000	5000	150X95	1	-	CACTUS5036	8031453022075	1/6	118,72

CACTUS503G

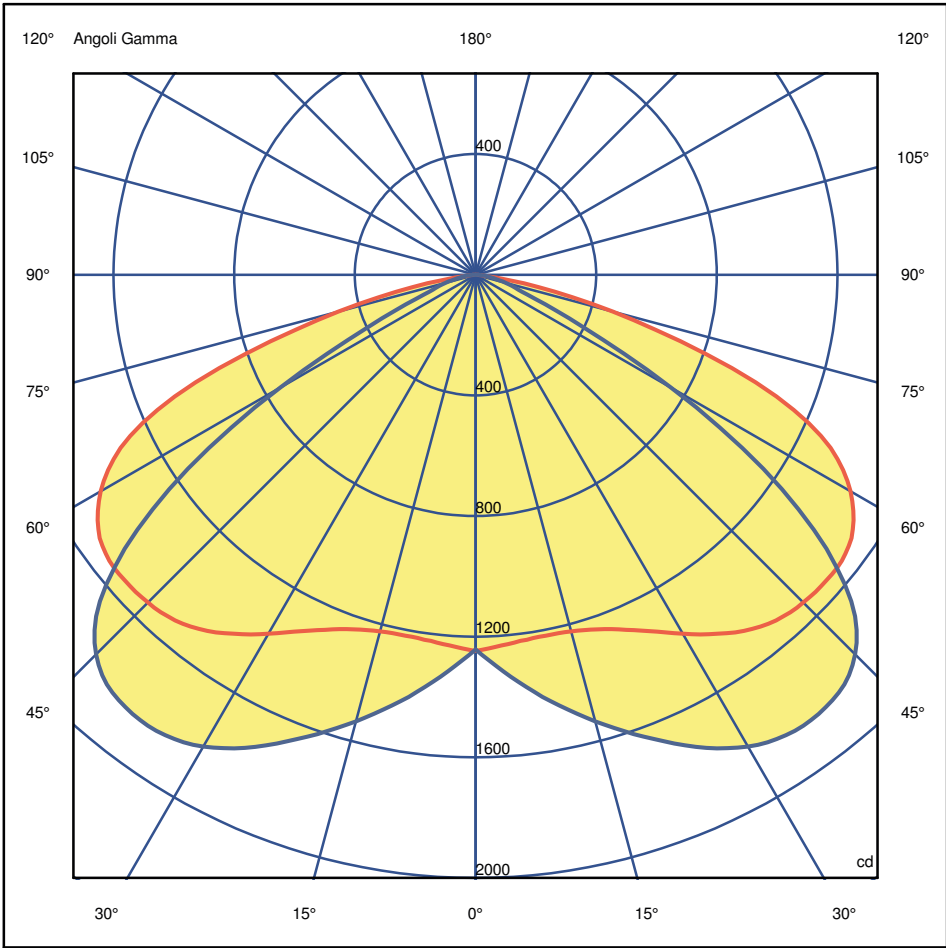

PLAFONIERA STAGNA A LED SLIM
SLIM LED TRI-PROOF

AGGIORNATO

BTL CATEGORIA SCONTO 24

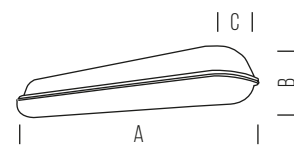

DIMENSIONI	A	B	C
1	650	80	78
2	1250	80	78
3	1550	80	78



IT

- Plafoniera stagna in policarbonato e ganci in acciaio
- Design slim
- Alta efficienza fino a 140 lm/W
- Lunga durata grazie ai suoi materiali resistenti all'acqua, polvere e corrosione

EN

- Tri-proof in polycarbonate with steel hooks
- Slim design
- High efficiency up to 140 lm / W
- Resistant to water, dust and corrosion

IP65

220v
240v

50.000 H

INSTANT

CLASS I

-20° +40°

NOT DIMMABLE

POTENZA WATT	BASE	KELVIN	LUMEN LM	FASCIO °	MISURE MM	VARIANTE	CODICE	EAN	IMBALLO	€ IVA ESCLUSA
18,0	-	4000	2500	120	1	-	LD2WPF183	8031453024482	1/8	46,64
30,0	-	4000	4200	120	2	-	LD2WPF303	8031453024499	1/6	65,72
55,0	-	4000	6600	120	3	-	LD2WPF553	8031453024505	1/6	79,50
65,0	-	4000	9100	120	3	-	LD2WPF653	8031453024512	1/6	97,52

PLAFONIERA STAGNA A LED SLIM - PASSANTE
 SLIM LED TRI-PROOF - PASS THROUGH

AGGIORNATO

BTL CATEGORIA SCONTO 24

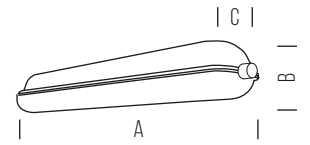

DIMENSIONI	A	B	C
2	1250	80	78
3	1550	80	78



IT

- Plafoniera stagna in policarbonato e ganci in acciaio
- Design slim
- Alta efficienza fino a 140 lm/W
- Lunga durata grazie ai suoi materiali resistenti all'acqua, polvere e corrosione.
- Collegamento passante per collegare tra di loro fino a 33 pezzi di LD2WPF303L o 18 pezzi di LD2WPF553L per un totale complessivo di 1000W

EN

- Tri-proof in polycarbonate with steel hooks
- Slim design
- High efficiency up to 140 lm / W
- Resistant to water, dust and corrosion
- Pass through connection in order to connect up to 33 pieces of LD2WPF303L or 18 pieces of LD2WPF553L for a total of 1000W

IP65

**220v
240v**

50.000H

INSTANT

CLASS I

-20° +40°

NOT DIMMABLE

POTENZA WATT	BASE	KELVIN	LUMEN LM	FASCIO °	MISURE MM	VARIANTE	CODICE	EAN	IMBALLO	€ IVA ESCLUSA
30,0	-	4000	4200	120	2	PASSANTE / PASS-THROUGH	LD2WPF303L	8031453024529	1/6	75,26
55,0	-	4000	6600	120	3	PASSANTE / PASS-THROUGH	LD2WPF553L	8031453024536	1/6	90,10

PLAFONIERA STAGNA A LED SLIM - EMERGENZA
SLIM LED TRI-PROOF - EMERGENCY

AGGIORNATO

BTL CATEGORIA SCONTO 24

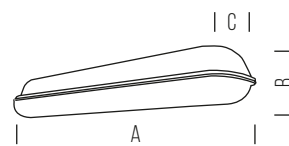

DIMENSIONI	A	B	C
2	1250	80	78
3	1550	80	78



IT

- Plafoniera stagna in policarbonato e ganci in acciaio
- Design slim
- Alta efficienza fino a 140 lm/W
- Lunga durata grazie ai suoi materiali resistenti all'acqua, polvere e corrosione
- Autonomia in emergenza 3h
- Tempo di ricarica 24h
- Lumen in emergenza 300lm

EN

- Tri-proof in polycarbonate with steel hooks
- Slim design
- High efficiency up to 140 lm / W
- Resistant to water, dust and corrosion
- Emergency autonomy period 3h
- Charging time 24h
- Emergency lumen output 300lm

IP65

220v
240v

50.000 H

INSTANT

CLASS I

-20° +40°

NOT DIMMABLE

3 H

POTENZA WATT	BASE	KELVIN	LUMEN LM	FASCIO °	MISURE MM	VARIANTE	CODICE	EAN	IMBALLO	€ IVA ESCLUSA
30,0	-	4000	4200	120	2	EMERGENZA / EMERGENCY	LD2WPF303E	8031453024543	1/6	132,50
55,0	-	4000	6600	120	3	EMERGENZA / EMERGENCY	LD2WPF553E	8031453024550	1/6	146,28

PLAFONIERA STAGNA A LED SLIM - RADAR
 SLIM LED TRI-PROOF - RADAR

AGGIORNATO

BTL CATEGORIA SCONTO 24

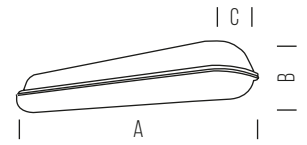

DIMENSIONI	A	B	C
1	650	80	78
2	1250	80	78
3	1550	80	78

RAGGIO DI RILEVAMENTO
DETECTION RANGE

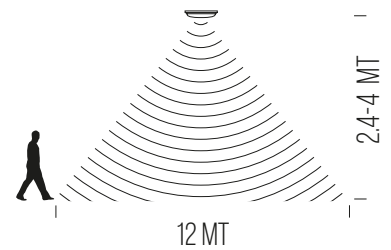

IT

- Plafoniera stagna in policarbonato e ganci in acciaio
- Design slim
- Alta efficienza fino a 140 lm/W
- Lunga durata grazie ai suoi materiali resistenti all'acqua, polvere e corrosione
- Sensore microonde programmabile mediante dip-switch (sensibilità, livello di luce ambiente, tempo di accensione)

EN

- Tri-proof in polycarbonate with steel hooks
- Slim design
- High efficiency up to 140 lm / W
- Resistant to water, dust and corrosion
- Option version with microwave sensor programmable by dip-switch (sensitivity, ambient light level, light switch-on time)

IP65

220v
240v

50.000 H

INSTANT

CLASS I

-20° +40°

NOT DIMMABLE

RADAR ON m

POTENZA WATT	BASE	KELVIN	LUMEN LM	FASCIO °	MISURE MM	VARIANTE	CODICE	EAN	IMBALLO	€ IVA ESCLUSA
18,0	-	4000	2500	120	1	SENSOR	LD2WPF183MW	8031453024680	1/6	80,56
30,0	-	4000	4200	120	2	SENSOR	LD2WPF303MW	8031453024574	1/6	98,58
55,0	-	4000	6600	120	3	SENSOR	LD2WPF553MW	8031453024581	1/6	112,36
65,0	-	4000	9100	120	3	SENSOR	LD2WPF653MW	8031453024598	1/6	131,44

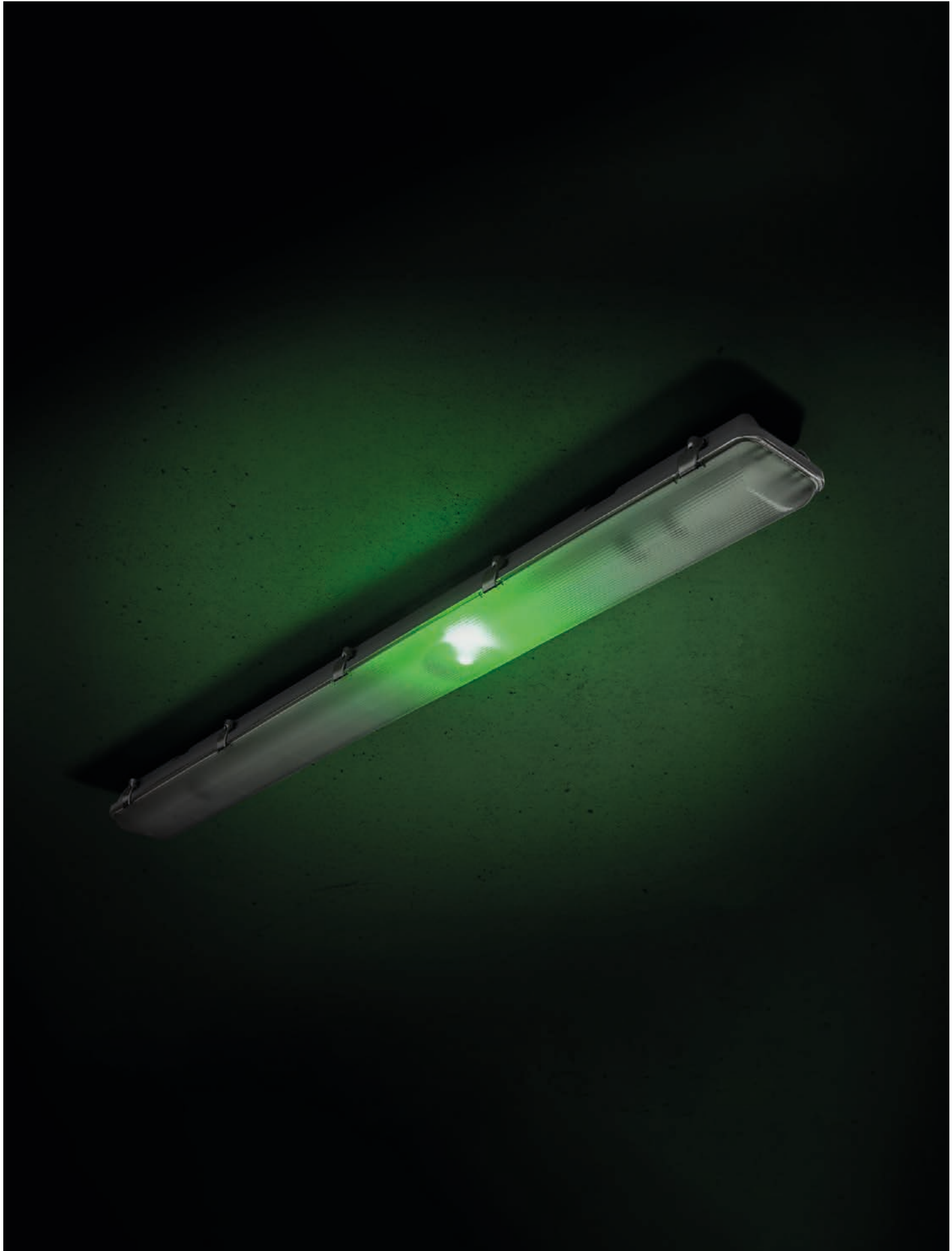

PLAFONIERA STAGNA A LED - EMERGENZA
 LED TRI-PROOF - EMERGENCY

BTL CATEGORIA SCONTO 24

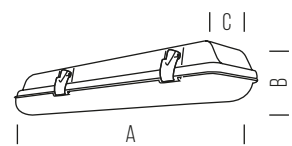

DIMENSIONI	A	B	C
1	1268	118	74
2	1568	118	74



IT

- Per funzionamento standard vedere LD1WPF403/LD1WPF583
- Autonomia in emergenza 3h
- Tempo di ricarica 24h
- Lumen in emergenza 430lm

EN

- For standard operation see LD1WPF403/LD1WPF583
- Emergency autonomy period 3h
- Charging time 24h
- Emergency lumen output 430lm



POTENZA WATT	BASE	KELVIN	LUMEN LM	FASCIO °	MISURE MM	VARIANTE	CODICE	EAN	IMBALLO	€ IVA ESCLUSA
40,5	-	4000	4600	180	1	EMERGENZA / EMERGENCY	LD1WPF403E3	8031453020323	1/5	179,14
58	-	4000	6700	180	2	EMERGENZA / EMERGENCY	LD1WPF583E3	8031453020330	1/5	196,10

PLAFONIERA STAGNA LED
LED TRI-PROOF

AGGIORNATO

BTL CATEGORIA SCONTO 24

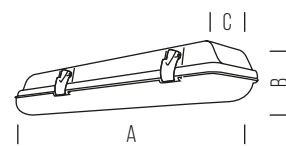

DIMENSIONI	A	B	C
1	658	118	74
2	1268	118	74
3	1568	118	74



IT

- Plafoniera stagna con schermo diffondente in policarbonato e ganci in acciaio
- Piastra a LED integrata di nuova generazione con prestazioni migliorate, offre ottimi risultati in termini di luminosità
- Lunga durata grazie ai suoi materiali resistenti all'acqua, polvere e corrosione
- Alta efficienza fino a 130 lm/W
- Eventuale schermo di ricambio da ordinare a parte

EN

- Waterproof luminaire with polycarbonate diffuser and steel hooks
- New generation integrated LED plate with improved performance offers excellent results in terms of brightness
- Long life thanks to materials that are water, dust and corrosion resistant
- High efficiency up to 130 lm/W
- Spare diffuser to be ordered separately

IP65

IK08

**220V
240V**

25.000 H

INSTANT

CLASS II

-20° * +40°

NOT DIMMABLE

POTENZA WATT	BASE	KELVIN	LUMEN LM	FASCIO °	MISURE MM	VARIANTE	CODICE	EAN	IMBALLO	€ IVA ESCLUSA
20	-	4000	2400	180	1	-	LD1WPF203	8031453017460	1/5	47,70
38	-	4000	4600	180	2	-	LD1WPF403	8031453017484	1/5	69,96
60	-	4000	7200	180	3	-	LD1WPF583	8031453017507	1/5	78,44
70	-	4000	9000	180	3	-	LD1WPF703	8031453022945	1/5	91,16

SCHERMO DI RICAMBIO PER PLAFONIERA STAGNA LED

SPARE DIFFUSER FOR LED TRI-PROOF

BTL CATEGORIA SCONTO 24

DIMENSIONI	LUNGHEZZA
1	658
2	1268
3	1568

POTENZA WATT	BASE	KELVIN	LUMEN LM	FASCIO °	MISURE MM	VARIANTE	CODICE	EAN	IMBALLO	€ IVA ESCLUSA
-	-	-	-	-	1	-	LD1WPFSC600	8031453011154	1/10	7,42
-	-	-	-	-	2	-	LD1WPFSC1200	8031453011178	1/10	13,78
-	-	-	-	-	3	-	LD1WPFSC1500	8031453011192	1/10	19,08

CLIP DI RICAMBIO PLAFONIERA STAGNA LED

SPARE CLIPS FOR LED TRI-PROOF

BTL CATEGORIA SCONTO 24

POTENZA WATT	BASE	KELVIN	LUMEN LM	FASCIO °	MISURE MM	VARIANTE	CODICE	EAN	IMBALLO	€ IVA ESCLUSA
-	-	-	-	-	-	-	LD1WPFCLIP	8031453022808	1	1,48

LED HIGH BAY

BTL CATEGORIA SCONTO 24

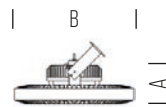

DIMENSIONI	A	B
1	149	420



IT

- Proiettore per illuminazione industriale ideale per la sostituzione degli apparecchi tradizionali a scarica da 250W e 400W in ambienti come magazzini, capannoni, grandi superfici.
- Corpo in pressofusione in alluminio ADC12 verniciata a polveri epossidiche in colore Grigio Agata RAL7038
- Vetro temperato spessore 4mm
- LED SMD 3030 ad alta efficienza (125lm/W) e CR>80
- Dimmer integrato 3 in uno (resistore, 1-10V, segnale PWM)
- Anello per montaggio a sospensione incluso
- Corpo IP65, di serie connettori IP65 per cavo di alimentazione e cavo dimmer
- Accessori opzionali: riflettori per fascio 60° o 90° colore esterno nero, staffa orientabile per montaggio a parete/soffitto

EN

- Floodlight for industrial lighting, ideal for replacing traditional 250W and 400W discharge lamps in environments such as warehouses, industrial sheds, places with large surface areas.
- Body in die-cast aluminium ADC12 with epoxy powder coated paint finish in Agate Grey RAL7038
- Tempered glass 4mm thick
- High efficiency SMD 3030 LED (125lm/W) and CR>80
- Built-in 3-in-1 dimmer (resistor, 1-10V, PWM signal)
- Hook for suspension mounting included
- Body rated IP65, series connectors rated IP65 for power cable and dimmer cable
- Optional accessories: reflectors for 60° or 90° beam black exterior, adjustable bracket for wall/ceiling mounting

IP65

220V
240V

50.000 H

INSTANT

CLASS I

-20° **+40°**

DIMMABLE

POTENZA WATT	BASE	KELVIN	LUMEN LM	FASCIO °	MISURE MM	VARIANTE	CODICE	EAN	IMBALLO	€ IVA ESCLUSA
150	-	4000	18000	120	1	-	LD1HB150G	8031453018399	1	450,00

STAFFA PER HIGH BAY LD1HB
 BRACKET FOR HIGH BAY LD1HB

BTL CATEGORIA SCONTO 24



POTENZA WATT	BASE	KELVIN	LUMEN LM	FASCIO °	MISURE MM	VARIANTE	CODICE	EAN	IMBALLO	€ IVA ESCLUSA
-	-	-	-	-	1	-	LD1HBKIT	8031453018467	1/10	15,50

DIFFUSORE PER HIGH BAY LD1HB 60°/90°
 DIFFUSER FOR HIGH BAY LD1HB 60°/90°

BTL CATEGORIA SCONTO 24

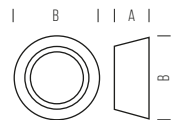

DIMENSIONI	A	B
1	172	408
2	250	527

POTENZA WATT	BASE	KELVIN	LUMEN LM	FASCIO °	MISURE MM	VARIANTE	CODICE	EAN	IMBALLO	€ IVA ESCLUSA
-	-	-	-	60	1	-	LD1HBREF60N	8031453015336	1/10	36,00
-	-	-	-	90	2	-	LD1HBREF90N	8031453015343	1/10	36,00

HIGH BAY - LED DOB

BTL CATEGORIA SCONTO 24

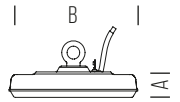

DIMENSIONI	A	B
1	105	241



IT

- Proiettore per applicazioni industriali ideale per la sostituzione degli apparecchi tradizionali a scarica da 250W in ambienti come magazzini, capannoni o grandi superfici in genere.
- Corpo in alluminio verniciato di colore nero
- Compatto e leggero grazie alla soluzione DOB (driver on board)
- Anello per montaggio a sospensione

EN

- Floodlight for industrial applications, ideal for replacing traditional 250W discharge lamps in environments such as warehouses, industrial sheds or places in general with large surface areas.
- Painted die-cast aluminium body
- Compact and lightweight thanks to DOB (driver on board)
- Hook for suspension mounting

IP65



35.000H

INSTANT

CLASS I

-20° +40°

NOT DIMMABLE

POTENZA WATT	BASE	KELVIN	LUMEN LM	FASCIO °	MISURE MM	VARIANTE	CODICE	EAN	IMBALLO	€ IVA ESCLUSA
100	-	4000	10000	90	1	-	LD2HB100N	8031453020545	1	127,20

STAFFA PER HIGH BAY LD2HB BRACKET FOR HIGH BAY LD2HB

BTL CATEGORIA SCONTO 24



CODICE	EAN	IMBALLO	€ IVA ESCLUSA
LD2HBKIT1	8031453020668	1/50	7,42

HIGH BAY LED
ALTA POTENZA
HIGH POWER

BTL CATEGORIA SCONTO 24

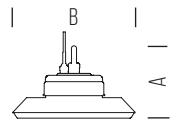

DIMENSIONI	A	B
1	178	301
2	198	301



IT

- Proiettore per applicazioni industriali ideale per la sostituzione degli apparecchi tradizionali a scarica da 250W e 400W in ambienti come magazzini, capannoni o grandi superfici in genere.
- Corpo in alluminio verniciato di colore nero
- Alta efficienza 130 lm/W
- Anello per montaggio a sospensione

EN

- Floodlight for industrial applications, ideal for replacing traditional 250W and 400W discharge lamps in environments such as warehouses, industrial sheds or places in general with large surface areas.
- Made from black painted aluminium
- High efficiency 130 lm/W
- Ring for suspension mounting

IP65

**220v
240v**

50.000H

INSTANT

CLASS I

**-20°
+40°**

NOT DIMMABLE

POTENZA WATT	BASE	KELVIN	LUMEN LM	FASCIO °	MISURE MM	VARIANTE	CODICE	EAN	IMBALLO	€ IVA ESCLUSA
150	-	4000	19500	120	1	-	LD2HB150N	8031453020552	1	333,90
200	-	4000	26000	120	2	-	LD2HB200N	8031453020569	1	418,70

STAFFE PER HIGH BAY LD2HB
BRACKETS FOR HIGH BAY LD2HB

BTL CATEGORIA SCONTO 24



CODICE	EAN	IMBALLO	€ IVA ESCLUSA
LD2HBKIT2	8031453020675	1/20	14,84
LD2HBKIT3	8031453020682	1/20	14,84

LD1HB150G-60°

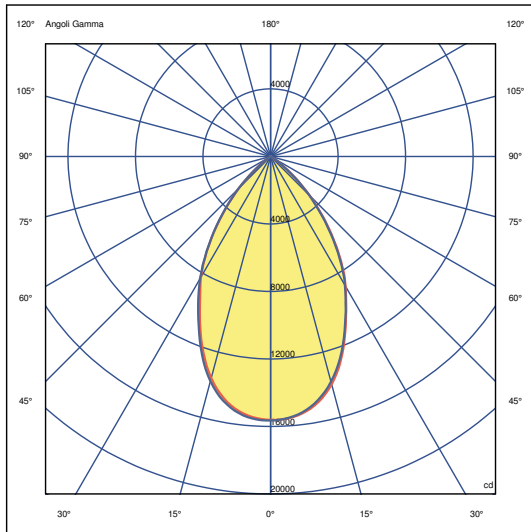

LD1HB150G-90°

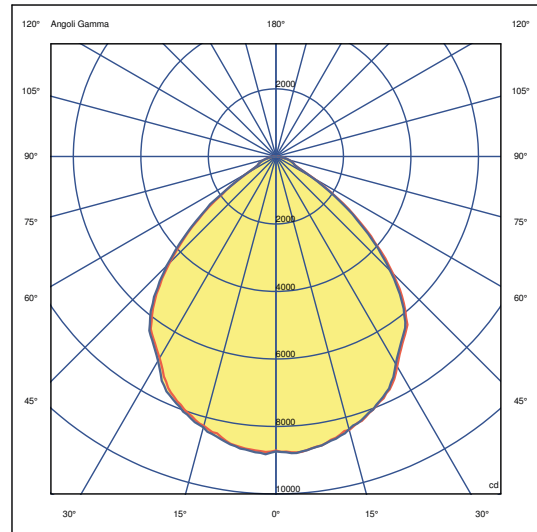

LD1HB150G-120°

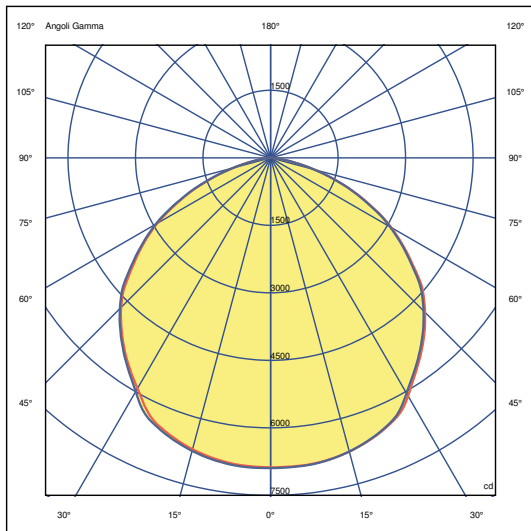

LD2HB100N

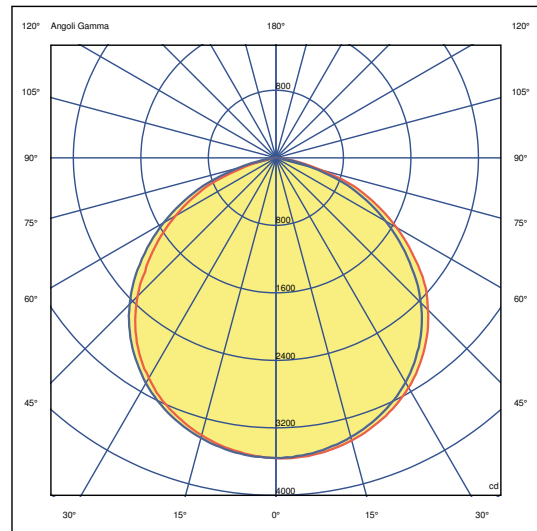

LD2HB150N

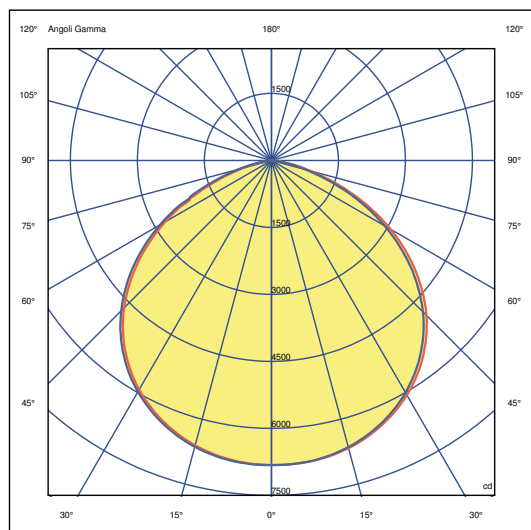

LD2HB200N

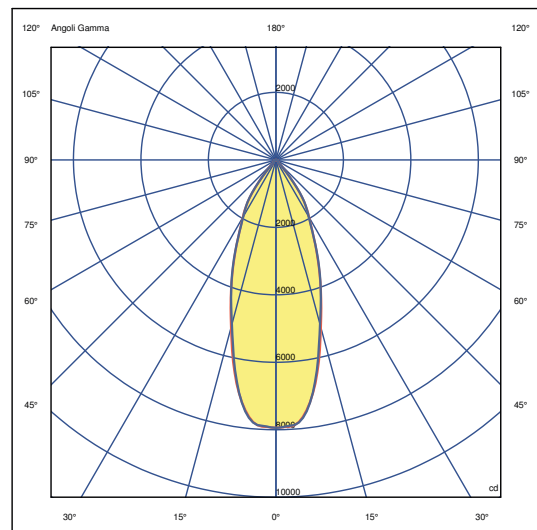



WORKLIGHT

LAMPADA DA TAVOLO CON LENTE DI INGRANDIMENTO 3D (1.75X) E CLIP DI FISSAGGIO
TABLE LAMP WITH 3D MAGNIFYING LENS (1.75X) AND FIXING CLIP

BTL CATEGORIA SCONTO 23

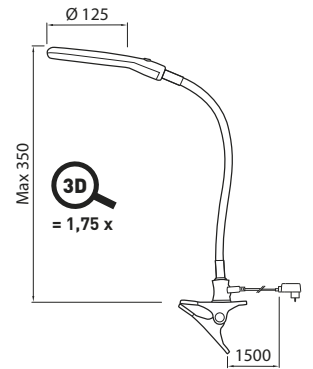

IT

- Grande lente in vetro 3D da 4" (1.75X) integrata nel corpo lampada
- Stelo pieghevole che consente una regolazione precisa
- Fissaggio tramite clip da tavolo per facilitare lo spostamento se necessario

EN

- Large 4" 3D magnifying lens (1.75X) incorporated into lamp body
- Flexible arm to allow precise adjustment
- Table clamp, making it easy to move elsewhere if necessary

IP20

220v
240v

20.000 H

INSTANT

CLASS II

-20° +40°

NOT DIMMABLE

POTENZA WATT	BASE	KELVIN	LUMEN LM	FASCIO °	MISURE MM	VARIANTE	CODICE	EAN	IMBALLO	€ IVA ESCLUSA
6	-	6500	570	-	1	-	4126205	6435200234599	1/10	66,78

LAMPADA DA TAVOLO CON LENTE DI INGRANDIMENTO 3D (1.75X) E CLIP DI FISSAGGIO A VITE

TABLE LAMP WITH 3D MAGNIFYING LENS (1.75X) AND SCREW FIXING CLIP

BTL CATEGORIA SCONTO 23

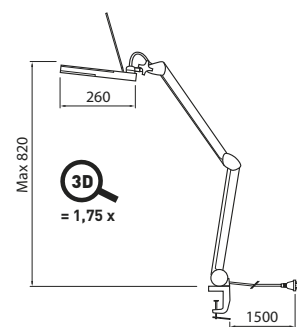

IT

- Grande lente in vetro 3D da 5" (1.75X) integrata nel corpo lampada
- Di facile installazione grazie al morsetto a vite che garantisce un fissaggio saldo alla superficie di lavoro.
- Braccio estensibile fino a 82 cm

EN

- Large 5" 3D magnifying lens (1.75X) incorporated into lamp body
- Easy to install thanks to screw-down bench bracket guaranteeing secure fixing to the work surface.
- Extending arm up to 82 cm

IP20

220v
240v

20.000 H

INSTANT

CLASS II

-20° +40°

NOT DIMMABLE

POTENZA WATT	BASE	KELVIN	LUMEN LM	FASCIO °	MISURE MM	VARIANTE	CODICE	EAN	IMBALLO	€ IVA ESCLUSA
8	-	6500	760	-	1	-	4118729	6435200219435	1/4	116,60

WORK 25

PROIETTORE PORTATILE A LED PROFESSIONALE
PROFESSIONAL PORTABLE LED FLOODLIGHT

BTL CATEGORIA SCONTO 24

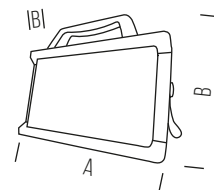

DIMENSIONI	A	B	C
1	290	234	83



IT

- Proiettore a LED portatile da cantiere
- Presa Schuko e presa USB 5V-1A integrate sul retro del proiettore
- Cavo H05RN-F3X1,5mm² lunghezza tre metri

EN

- Portable worksite LED floodlight
- Schuko plug and 5V-1A USB socket on rear of floodlight
- Cable H05RN-F3X 1.5mm² 3 metres long

IP54



30.000 H

INSTANT

CLASS II

-20° +50°



POTENZA WATT	BASE	KELVIN	LUMEN LM	FASCIO °	MISURE MM	VARIANTE	CODICE	EAN	IMBALLO	€ IVA ESCLUSA
25	-	4000	2000	100	1	-	WORK25	8031453019730	1/6	92,22

WORK 45

PROIETTORE PORTATILE A LED PROFESSIONALE
PROFESSIONAL PORTABLE LED FLOODLIGHT

BTL CATEGORIA SCONTO 24

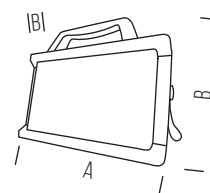

DIMENSIONI	A	B	C
1	385	315	90



IT

- Proiettore a LED portatile da cantiere
- Due prese Schuko integrate sul retro del proiettore
- Interruttore a tre posizioni: OFF - 50% - 100%
- Cavo H05RN-F3X1,5mm² lunghezza tre metri

EN

- Portable worksite LED floodlight
- Two Schuko plugs on rear of floodlight
- Three-position switch: OFF - 50% - 100%
- Cable H05RN-F3X 1.5mm² 3 metres long

IP54



30.000 H

INSTANT

CLASS II

-20° +50°



POTENZA WATT	BASE	KELVIN	LUMEN LM	FASCIO °	MISURE MM	VARIANTE	CODICE	EAN	IMBALLO	€ IVA ESCLUSA
45	-	4000	3800	100	1	-	WORK45	8031453019723	1/4	122,96



FIORA

LAMPADA A SOSPENSIONE A LED PER CRESCITA PIANTE
LED SUSPENSION LAMP FOR PLANT GROWTH

BTL CATEGORIA SCONTO 23

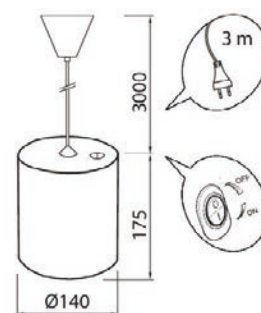

IT

- Corpo in policarbonato di colore bianco con interruttore ON/OFF integrato e riflettore lucido
- Lampada LED PAR30 intercambiabile in dotazione (COD. 4711773)
- Emissione di luce rossa e luce blu, che favoriscono la crescita della piante. Non emette alcuna radiazione UV
- Montaggio a soffitto, cavo di lunghezza 3 metri e coppa da soffitto inclusi

EN

- White polycarbonate body with integrated ON/OFF switch and polished reflector
- Interchangeable LED PAR30 light bulb supplied (CODE 4711773)
- Emission of blue light and red light to stimulate plant growth. No UV radiation emitted
- Ceiling mounted, 3-metre long cable and ceiling cup included

IP20
220v 240v
15.000 H
INSTANT
CLASS II
-20° +40°
NOT DIMMABLE

POTENZA WATT	BASE	KELVIN	LUMEN LM	FASCIO °	MISURE MM	VARIANTE	CODICE	EAN	IMBALLO	€ IVA ESCLUSA
10	E27	4000	800	30	1	-	4118787	6435200228246	1/8	40,28



HERBY

LAMPADA DA TAVOLO A LED PER CRESCITA PIANTE
LED TABLE LAMP FOR PLANT GROWTH

BTL CATEGORIA SCONTO 23

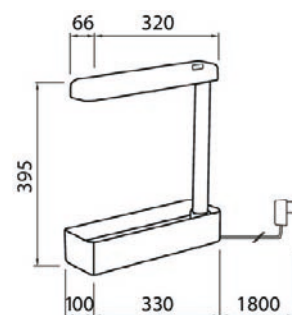

IT

- Corpo in policarbonato bianco con interruttore integrato
- Doppio funzionamento, come una normale lampada da tavolo con emissione di luce 4000K o con emissione di luce blu e luce rossa per favorire la crescita delle piante
- Ideale per piante aromatiche o piante di piccolo taglio
- Dotato di spina elettrica con trasformatore a 24V e cavo da 1,8metri

EN

- White polycarbonate body with integrated switch
- Double operation, like a normal table lamp with emission of 4000K light or with emission of blue light and red light to stimulate plant growth
- Ideal for aromatic or small plants
- Fitted with electric plug with 24V transformer and 1.8-metre cable

IP20

220v
240v

25.000 H

INSTANT

CLASS II

-20° **+40°**

NOT DIMMABLE

POTENZA WATT	BASE	KELVIN	LUMEN LM	FASCIO °	MISURE MM	VARIANTE	CODICE	EAN	IMBALLO	€ IVA ESCLUSA
12	-	4000	800	-	1	-	4118786	6435200228222	1/6	82,68

FLUSSO LUMINOSO
LUMINOUS FLUX

1500
l u m e n

La quantità totale di luce emessa, o flusso luminoso, si misura in lumen (lm). Il numero di lumen emessi è il parametro fondamentale che permette al consumatore di scegliere una lampada in funzione del suo impiego.

The total quantity of light emitted by a lamp, or luminous flux, is measured in lumens (lm). The number of lumen emitted is the basic parameter which allows the consumer to choose a lamp in relation to its intended use.

INTENSITÀ MASSIMA
MAXIMUM INTENSITY

1100 cd

Nelle lampade con emissione direzionale, oltre alla quantità totale di luce emessa (lumen), viene anche indicata l'intensità massima espressa in candele (cd).

In lamps with directional emission, in addition to the total quantity of light emitted (lumen), also the maximum intensity is given in candelas (cd).

AMPIEZZA FASCIO LUMINOSO
LIGHT BEAM ANGLE

160°

Nelle lampade con emissione direzionale è indicata l'ampiezza del fascio luminoso espressa in gradi.

In lamps with directional emission the angle of the light beam is given in degrees.

EQUIVALENZA CON SORGENTE TRADIZIONALE
WATTAGE EQUIVALENT

10W=
100w

Il Watt (W) è l'unità di misura della potenza elettrica assorbita. A sinistra è indicato il consumo della lampada mentre a destra è indicato il consumo (maggiore) di una sorgente tradizionale, incandescente od alogena, che produce un flusso luminoso equivalente.

The Watt (W) is the unit of measurement of absorbed electrical power. The consumption of the lamp is indicated to the left, while on the right is the consumption (higher) of a traditional source, whether incandescent or halogen, which produces an equivalent luminous flux.

COLORE DELLA LUCE
LIGHT COLOUR



Una luce bianca viene caratterizzata dalla Temperatura di Colore, espressa in Kelvin (K). Una luce calda ha una temperatura di colore più bassa, tipicamente 2700-3000K, mentre una luce fredda ha una temperatura di colore elevata (5000-6500K). L'imballo riporta sia la descrizione sia la scala graduata con il valore esatto.

A white light is characterised by the Colour Temperature, given in Kelvin (K). A warm light has a lower colour temperature, usually 2700-3000K, while a cold light has a high colour temperature (5000-6500K). The packaging gives both the description and the graduated scale with the exact value.

TEMPO DI AVVIO
WARM-UP TIME

INSTANT

Indica il tempo necessario a raggiungere il 60% dell'emissione luminosa a regime.

This indicates the time necessary to reach 60% of maximum light output.

VITA NOMINALE
NOMINAL LIFETIME

35.000 H

Indica la durata prevista a cui sopravvive il 50% delle lampade in un lotto campione e viene espresso in ore.

Nel caso di lampade LED, si considera la lampada esaurita quando il flusso luminoso si abbassa del 30% rispetto ai valori iniziali.

This indicates the expected lifetime after which 50% of the lamps in a sample lot will have failed and is given in hours. In the case of LED lamps, the lamp is considered as having failed when the luminous flux drops by 30% compared to initial values.

ACCENSIONI
NUMBER OF ON/OFF CYCLES

30.000

Accensioni e spegnimenti ripetuti possono danneggiare la lampada. Viene riportato il numero di accensioni per cui la lampada è collaudata.

Repeated on/off cycles could damage the lamp. The number of on/off cycles for which the lamp has been tested is given.

UTILIZZO CON DIMMERS
DIMMER



Il simbolo indica se la lampada può essere o non può essere utilizzata con regolatori di luce.

Dimmerable or not.

UTILIZZO IN APPARECCHI APERTI
USE IN OPEN LUMINAIRES



Lampada adatta all'impiego in apparecchi sprovvisti di vetro di protezione. Per lampade LED si consiglia l'impiego in apparecchi aperti al fine di garantire una corretta ventilazione.

Lamp suitable for use in luminaires with no glass protective shield. Use of LED bulbs is recommended in open luminaires to ensure correct ventilation.



Lampada con doppio fusibile all'interno del corpo

Lamp with double fuse, internally mounted.



Lampada con flusso luminoso di tipo direzionale

Lamp with directional type luminous flux.



Temperatura ambiente entro la quale l'apparecchio può lavorare correttamente

Ambient temperature within which the luminaire operates correctly.



Apparecchio con grado di protezione agli agenti esterni IPXY es: IP65/44/20...

Luminaire with ingress protection rating IPXY ex: IP65/44/20...



Alta resa dei colori

High colour rendering



Apparecchio provvisto di collegamento di messa a terra di protezione

Luminaire with earth/ground connection.



Apparecchio che non richiede la connessione di messa a terra perché dotato di un doppio involucro di materiale isolante.

Luminaire that does not require earth/ground connection because double insulated.



Pack Blister

Blister pack



Collegamento a tensione di rete possibile

Connection to mains power possible



Lampada con tecnologia a ioduri metallici

Metal iodide lamp



Lampada con tecnologia al ioduri metallici e bruciatore ceramico

Metal iodide lamp with ceramic burner



Lampada con tecnologia al sodio

Sodium lamp



Apparecchio con la possibilità di regolare il tempo di accensione

Luminaire with possibility of adjusting operating time



Apparecchio con la possibilità di regolare la distanza di rilevamento movimento

Luminaire with possibility of adjusting motion detection distance



Apparecchio con rilevatore di movimento a microonde

Luminaire with microwave motion detector



Sensore passivo ad infrarossi

Passive infrared sensor



Apparecchio con accensione automatica con la possibilità di regolare la sensibilità alla luce

Luminaire with automatic switching on and possibility of adjusting sensitivity to light



Collegamento alla presa dell'auto a 12V possibile.

Connection to 12V car socket possible



Durata della batteria

Battery duration



Apparecchio con rilevatore di movimento a microonde. Con la possibilità di:
-regolare il tempo di accensione.
-regolare la distanza di rilevamento movimento.
-regolare la sensibilità alla luce.

Luminaire with microwave motion detector. With the possibility of:
-adjusting operating time.
-adjusting motion detection distance.
-automatic switching on and possibility of adjusting sensitivity to light.



Apparecchio a funzione luce di emergenza con:
-durata della batteria espresso in ore.
-lumen massimi in funzione emergenza.

Emergency light luminaire with:
-battery life expressed in hours.
-maximum lumens with emergency function.



WIRELESS: apparecchio controllabile senza fili.
WIRELESS: wireless controllable appliance.



Tunable White: apparecchio con temperatura di colore regolabile.
Tunable White: Luminaire with adjustable color temperature.



RGB: Led con luce rossa, verde e blu; possibilità di variare la tonalità e saturazione di colore.
RGB: Red Green Blue leds, possibility to vary the hue and color saturation.



Dimmerazione tramite app.
Dimmable with app.

GARANZIA LAMPADE A LED BOTLIGHTING

Qualità del prodotto, tecnologia innovativa, durata e caratteristiche illuminotecniche risultano gli elementi vincenti delle lampade a LED di Bot Lighting, per questo motivo abbiamo deciso di offrire un vantaggio esclusivo al nostro cliente.

2 ANNI
YEARS
WARRANTY
GARANZIA

LAMPADE CON VITA
MEDIA NOMINALE
< 25.000 ORE

3 ANNI
YEARS
WARRANTY
GARANZIA

LAMPADE CON VITA
MEDIA NOMINALE
≥ 25.000 ORE
E MINORE DI
40.000 ORE

5 ANNI
YEARS
WARRANTY
GARANZIA

LAMPADE CON VITA
MEDIA NOMINALE
≥ 40.000 ORE

La presente garanzia copre esclusivamente i Prodotti impiegati alle seguenti condizioni di utilizzo che devono verificarsi contemporaneamente ai fini della copertura di garanzia:

- I prodotti devono essere installati correttamente ed utilizzati secondo le istruzioni.
 - Controllare che i parametri elettrici dell'impianto siano compatibili con l'apparecchio prima di installarlo
 - Il periodo di garanzia presuppone un utilizzo di funzionamento massimo di 4.000 ore all'anno ad una temperatura massima di 25°C.
 - Il periodo di garanzia decorre a partire dalla data di acquisto riportata sulla fattura/scontrino fiscale e/o dal lotto di produzione riportato su ciascun prodotto.
 - L'apparecchio dovrà essere destinato esclusivamente all'uso per il quale è stato espressamente concepito. Ogni altro uso sarà da considerarsi improprio.
 - Gli apparecchi a LED sono progettati per essere installati in ambienti con una adeguata ventilazione, al fine di garantirne una corretta dissipazione del calore, pertanto non coprire ne avvolgere l'apparecchio o il relativo alimentatore in nessun caso.
- L'impiego in contesti non adeguati ne può ridurre sensibilmente la durata e ne invalida la garanzia.

Approfondimento termini e condizioni di garanzia
www.botlighting.it/garanzia

1. Gli ordini sono subordinati all'accettazione del fornitore. Le offerte ed accettazioni di ordini si intendono ai prezzi ed alle condizioni di vendita in vigore al momento della spedizione della merce, salvo disponibilità. Gli ordini anche se raccolti tramite il nostro personale di vendita, sono vincolati all'accettazione da parte di BOT LIGHTING Srl, che può essere anche parziale.
2. Alla Venditrice non potrà essere addossata alcuna responsabilità per mancata accettazione, ovvero per mancata o ritardata fornitura dei prodotti oggetto dello stesso. L'accettazione e l'esecuzione dell'ordine sono specificatamente subordinate alla disponibilità dei prodotti ordinati nonché all'assenza di circostanze che possano comunque influire sulla reperibilità degli stessi e sulla loro tempestività di consegna. I termini di consegna sono indicativi e l'acquirente non può pretendere la rifusione di danni in caso di ritardi nelle consegne per cause non imputabili al fornitore. Gli eventuali ritardi nelle consegne, così come le interruzioni e/o sospensioni totali o parziali delle forniture, anche se non dovute a causa di forza maggiore e/o caso fortuito, non daranno diritto al risarcimento di danni e/o indennizzi di qualsiasi tipo, ivi inclusi quelli diretti, indiretti e consequenziali, nonché interessi.
3. La merce viaggia a rischio e pericolo dell'acquirente e in caso di furti, manomissioni, l'acquirente dovrà rivolgersi esclusivamente al vettore. In qualsiasi caso le anomalie riscontrate alla consegna dovranno essere notificate a BOT LIGHTING Srl con la seguente modalità:
 - nel caso di colli sfusi verificare sempre all'atto della consegna il numero esatto dei colli e le eventuali rotture. Eventuali riserve precise dovranno sempre esser verbalizzate sul documento di trasporto e sull'eventuale bollettino del trasportatore.
 - nel caso di bancali e quindi di impossibilità al controllo immediato alla consegna è necessario accettare la consegna stessa con "riserva di verifica" da esser segnalata nell'apposito riquadro del documento di trasporto e nell'eventuale bollettino del corriere.I reclami dovranno pervenire a BOT LIGHTING Srl entro 3 giorni dal ricevimento del materiale.
4. Non appena ricevuti i prodotti, l'Acquirente sarà tenuto a verificare lo stato, la quantità della fornitura e la sua rispondenza alla bolla di consegna. Eventuali reclami in merito alla qualità, quantità, tipo del prodotto, dovranno essere fatti per iscritto entro 5 (cinque) giorni dalla data di ricevimento della merce. Decorso tale termine, fatte comunque salve le diverse condizioni di garanzia previste per i singoli prodotti, nessun reclamo potrà essere avanzato sia per la sostanza e la qualità della merce, sia per le condizioni in genere della stessa.
5. Eventuali difetti di fabbricazione dovranno essere tempestivamente denunciati e, dopo verifica di accertamento, saranno dal fornitore accreditati in toto od in parte, oppure sostituiti. Eventuali resi dovranno esser preventivamente concordati con il fornitore e si intendono "salvo verifica".
6. I prezzi di listino formulati si intendono per merce franca presso il deposito del fornitore; imballi speciali, assicurazione, resa e trasporto, imposte e tasse (IVA, ecc.) sono addebitabili a parte. Il prezzo indicato in tabella è da considerarsi come prezzo suggerito al pubblico.
7. Nel commercio dei prodotti, oggetto del contratto, l'acquirente si asterrà da qualsiasi atto contrario ai principi della concorrenza leale, in conformità alle leggi, ai regolamenti nonché agli usi, in quanto compatibili.
8. Il pagamento della merce, nei termini ed alle condizioni di volta in volta stabiliti, dovrà esser effettuato presso il domicilio del fornitore, oppure ad un incaricato a ciò espressamente delegato. In quest'ultimo caso i pagamenti non si intendono effettuati finché le relative somme non pervengano alla sede centrale. Il mancato rispetto delle condizioni di pagamento stabilite o pagamenti differiti rispetto alle condizioni inizialmente concordate, determineranno l'applicazione degli interessi di mora, decorrenti dalla data di scadenza di pagamento della fattura e da determinarsi in base alla normativa di legge al momento vigente. In caso di controversia, per qualsiasi ragione, l'acquirente non ha alcun diritto di ritardare o di rifiutare il pagamento delle fatture scadute. Eventuali sconti cassa, nonché abbuoni o premi di qualsiasi natura saranno riconosciuti a condizione che il cliente non abbia pagamenti in sospeso e si intenderanno automaticamente decaduti e revocati in caso di mancato o ritardato pagamento. Ci riserviamo la facoltà di non dare esecuzione agli ordini di acquirenti che non abbiano provveduto al puntuale pagamento di forniture precedenti.
9. In caso di controversie si stabilisce la competenza esclusiva del Foro di Venezia.
10. La BOT LIGHTING Srl è impegnata a sviluppare e migliorare i propri prodotti. Per questa ragione tutte le descrizioni di questo catalogo-listino sono intese come guida generale e le specifiche possono essere cambiate di volta in volta nell'interesse del miglioramento del prodotto. Inoltre, eventuali modifiche sulle caratteristiche e sulla gamma di prodotti commercializzati che possono essere apportati dai produttori in qualsiasi momento senza preavviso, escludono la Bot Lighting Srl da alcuna responsabilità.

BOTLIGHTING LED LAMPS WARRANTY

Product quality, innovative technology, duration and lighting engineering features make the LED lamps by Bot Lighting a sure success, which is why we are offering our customers an exclusive advantage.

2 ANNI
YEARS
WARRANTY
GARANZIA

LAMPS WITH NOMINAL
AVERAGE LIFETIME
< 25,000 HOURS

3 ANNI
YEARS
WARRANTY
GARANZIA

LAMPS WITH NOMINAL
AVERAGE LIFETIME
≥ 25,000 HOURS
AND LESS THAN
40,000 HOURS

5 ANNI
YEARS
WARRANTY
GARANZIA

LAMPS WITH NOMINAL
AVERAGE LIFETIME
≥ 40,000 HOURS

This warranty only covers Products used according to the conditions of use listed below, which must all be met for the purpose of warranty coverage.

- The products must be properly installed and used in accordance with the manufacturer's instructions.
- Check the electrical parameters of the system if they are compatible with the product before installing it.
- The warranty period is based on a maximum burning behaviour of 4,000 hours a year at a maximum temperature of 25 °C.
- The warranty period starts on the date of purchase shown on the invoice/receipt and/or the production batch shown on each product.
- The fixture must only be used for the purpose for which it was designed. Any other form of use should be considered improper.
- The LED fixtures are designed for installation in positions where it can receive enough ventilation to allow adequate heat dissipation, do not cover or wrap the appliance or its driver under any circumstances.

The use in contexts not adequate can considerably reduce the lifetime and invalidates the warranty.

1. Orders are subject to acceptance by the supplier. Quotations and acceptances of orders are agreed as at the prices and on the terms and conditions of sale in force at the time of dispatching the goods, subject to availability. Even if orders have been taken through our sales staff, final acceptance, which may be partial, has to be made by BOT LIGHTING Srl.
2. The Seller shall not be held liable for non-acceptance or for failure or delay in supplying the products forming the subject matter of the supply. Acceptance and processing of the order are specifically subject to the availability of the ordered products as well as the absence of circumstances which could in any way affect the availability of the same and prompt delivery thereof. The delivery times are given as an indication and the buyer may not make any claim in the event of delays in deliveries due to causes not attributable to the supplier. Any delays in deliveries, as also total or partial stoppages or suspensions of supplies, even when not due to force majeure, do not entitle the customer to claim for damage or loss, whether direct, indirect or consequential, or indemnity of any type whatsoever, or interest.
3. The goods travel at the buyer's risk and in the event of theft or tampering, the buyer shall contact the carrier, whereas any faults or defects found at the time of delivery shall be reported to BOT LIGHTING Srl as follows:
 - in the case of loose packs, always check at the time of delivery the precise number of packs and check for any breakages. Any reservations shall always be written on the transport document and on any carrier's delivery note.
 - in the case of pallets and therefore the impossibility of an immediate check of the goods, it is necessary to accept the delivery with "subject to checking" to be written in the relative box on the transport document and on any carrier's delivery note. Complaints shall be sent to BOT LIGHTING Srl within 3 days of receiving the material.
4. The Buyer is obliged to check the state and quantity of the supply as well as its compliance with the delivery note as soon as the products have been received. Any complaints regarding quality, quantity and type of product shall be made in writing within 5 (five) days from the date of receiving the goods. After that period, without prejudice to other warranty conditions given for single products, no complaint may be made either for the substance and quality of the goods or for the general conditions of the same.
5. Any manufacturing defects shall be promptly reported and, after verification and assessment, the goods will either be replaced or the amount paid for the same credited in full or in part to the customer by the supplier. Any returns shall be previously agreed with the supplier and are agreed as "subject to verification".
6. The list prices given are agreed as for goods ex supplier's warehouse; special packaging, insurance, delivery and transportation, duties and taxes (VAT, etc.) are charged separately. The price indicated is to be considered the recommended retail price.
7. In selling the products forming the subject matter of the contract, the buyer will refrain from any act contrary to the principles of fair competition, in compliance with the law, regulations and accepted practice, insofar as they are compatible.
8. The goods shall be paid, within the times and on the conditions established case by case, c/o the domicile of the supplier or to an expressly designated person. In the latter case the payments are not considered as made until the relative sums are received at head office. Failure to comply with the established conditions of payment or deferred payments in respect of the initially agreed conditions will result in the application of default interest as from the due date of payment of the invoice, to be determined according to the provisions of law in force at the time. In the event of a dispute, for any reason whatsoever, the buyer is not entitled to delay or to refuse payment of the overdue invoices. Any cash discounts as well as allowances or bonuses of any kind will be acknowledged provided that the customer has no outstanding payments, but will be agreed as automatically forfeited and revoked in the event of late or non-payment. We reserve the right not to carry out the orders of buyers who have not arranged for punctual payment of previous supplies.
9. In the event of disputes, it is established that the Court of Venice shall have sole jurisdiction.
10. BOT LIGHTING Srl is committed to developing and improving its products. All the descriptions in this catalogue-price list are therefore agreed as being a general guide and the specifications may be changed from time to time in the interests of product improvement. Furthermore, Bot Lighting Srl cannot be held liable for any changes to the characteristics and the range of outsourced products, which may be introduced by the manufacturers at any time without notice.

BOT LIGHTING
FOR A BRIGHT FUTURE

SHOT
BOT LIGHTING

AIRAM
BOT LIGHTING

Bot Lighting srl

Via Lombardia 37/39

30030 Cazzago di Pianiga (VE) · Italy

T. +39 041 51 29 411

F. +39 041 51 01 715

www.botlighting.it

info@botlighting.it
ordini@botlighting.it

